

MAN POWERED AIRCRAFT SINCE 1963

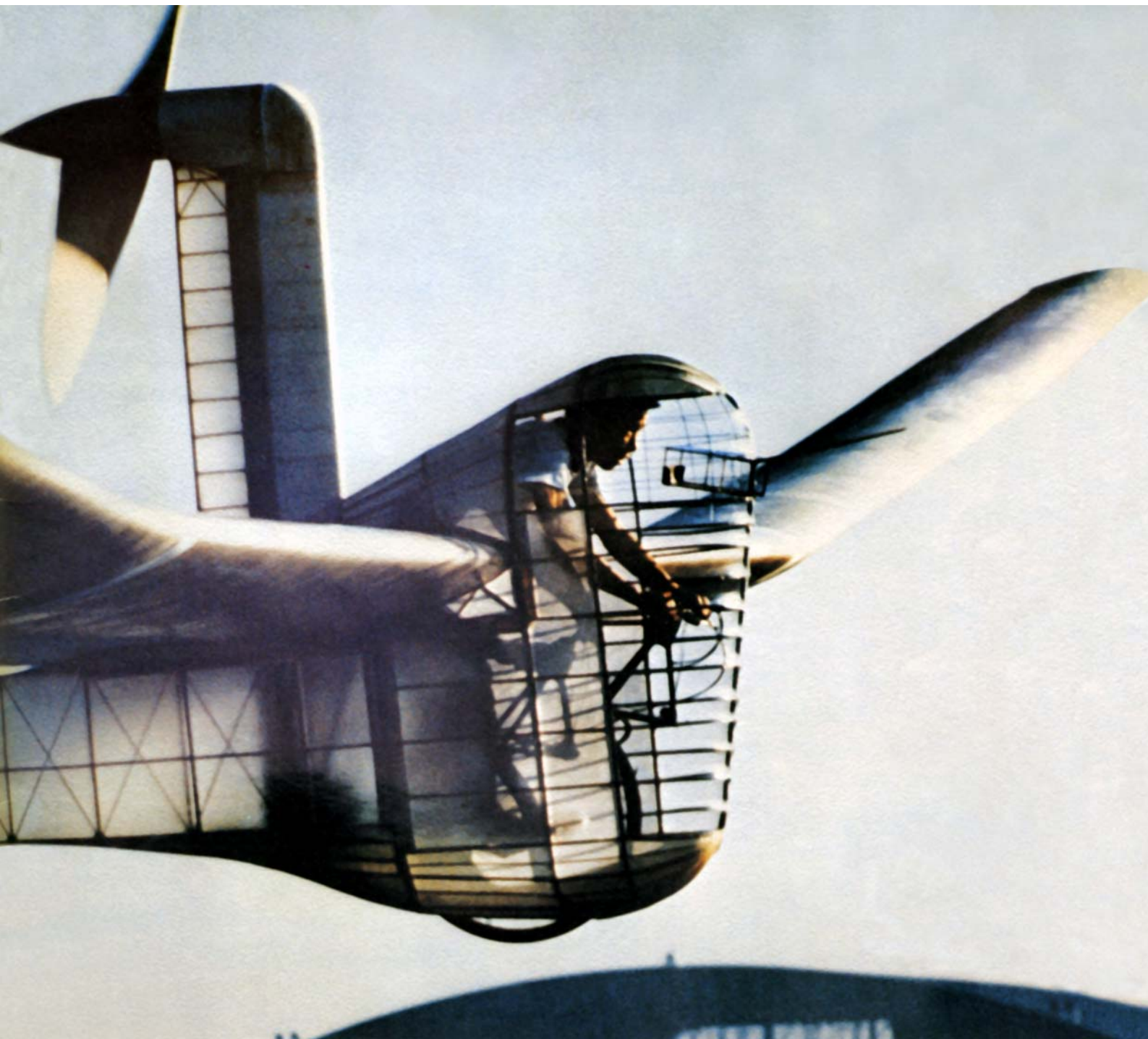

The Research Institute
of
Science and Technology
Nihon University
June 1977

Development of man-powered aircraft in Nihon University since 1963

Hidemasa Kimura, Professor Emeritus.

The idea of developing Japan's first man-powered aircraft at the hands of students was conceived by Nihon University in 1961 soon after the news of successful flights of Britain's "SUMPAC" and "Puffin" were received. At that time, thesis on man-powered aircraft were in short supply even in Britain which pioneered the aircraft. No single piece of reference material, such as detailed design data, was available. It was therefore decided to take up the development of man-powered aircraft as the graduation thesis of senior students of Nihon University's Mechanical Engineering Department, thereby building up the experience step by step.

April 1963 marked the beginning of the first year of research. The theme selected was the source of power for the aircraft -- human power. A device to measure the power generated when man steps on the pedal was manufactured on an experimental basis. A variety of experiments were conducted with the device, using students. The experiments definitely served to establish the characteristics of man as a power generating organ.

The second year was devoted to operations research to determine the optimum airframe dimensions, weight, aerodynamic characteristics and other factors to make man-powered flight possible. The basic form of the airframe was defined on the basis of the research. The third year marked a transition to detail design and manufacturing. The long-awaited aeroplane was rolled out in February 1966. The plane was expected to be able to lift off the ground but not fly so long. As a token of modesty, the aircraft was christened the LINNET, a little bird whose flying performance is considered rather unimpressive. Nihon University at that time did not have a runway of its own ready. Consequently, airframe assembly and test flight were carried out at Chofu Airfield.

On February 25, 1966, our dear LINNET, with Munetaka Okamiya (an IBM employee at present) at the controls, lifted wheels off the ground for the first time. The following day, the bird flew some 15 meters, marking Japan's first successful steady flight of man-powered aircraft. The LINNET thus achieved the distinction of the world's fourth man-powered aircraft, following three British aircraft, the SUMPAC, Puffin I and Puffin II.

Because of his aerial feat, Mr. Okamiya became the first Japanese who was able to walk on the ground, swim at sea and fly in the air using his own power. He chalked up the longest flying record of 41 meters in later test flights.

Following the initial flight program, trial manufacturing of subsequent models continued at a pace of one aeroplane almost every year, except for the period during which the university was embroiled in faculty-students disputes. The LINNET series were built up to the fifth model, using more or less the same basic form. The last model, however, remained unfinished. Such series of research efforts had most satisfactory educational effects on the students but did not produce any remarkable progress in the performance of man-powered aircraft, the longest flying record being only 91 meters registered by the II model.

In spite of that, we became confident that man-powered aircraft, which had hitherto been nebulous entity, are flyable without fail once we build them with our own hands. This was a great reward. Such accomplishment, of course, was made possible by extraordinary efforts and

dedication of the students. It turned out that building man-powered aircraft was not as easy a job as was manageable in the realm of a personal hobby. The key to the reasonable success of every flight of the LINNET series was the weight reduction of the airframe. In effecting the reduction, we came to realize that use of styrene-paper as the outer cover of the airframe would do the trick. This proved to be a particularly effective contributing factor. The outer cover of this kind is a thin sheet made by rolling styrol-resins at a thickness of about 0.5 mm. Such material is light and effective in enhancing the rigidity of the airframe. It is also smooth in outer surface finish, a quality which is far superior to that of Britain's Melinex whose surface is slackened like a wet paper screen when used as the outer covering of airframe. There is a legend that use of styrene-paper for the outer cover dawned on a student when he saw sashimi (raw fish) being sold in a vessel made of that material. Combined use of styrene-paper with "washi" (Japanese paper) is producing even better results these days.

The basic form of the LINNET series embodied the original beauty which was unparalleled. What was wrong with it was that a torque shaft measuring about four meters long was needed to transmit the power of the pilot from the pedal to the propeller because the propeller was located at the tail end.

The vibration of the shaft, which was witnessed in the initial phase of the program, was solved by increasing its outer diameter. The shaft, however, could not be elongated beyond reasonable limits. This made it impossible to elongate the moment arm of the tail. (The tail volume of the horizontal tail was 0.305 for the I model and 0.334 for the II model.) Such structural deficiency brought on insufficient longitudinal stability, which caused the pilot constantly to pay his exclusive attention to the maintenance of longitudinal trim. It was not easy to attend to the delicate manoeuvring of the aeroplane while pedalling with both feet at full power simultaneously. There were many cases in which the aeroplane prematurely hit the ground as a result of a loss of foot power caused by excessive attention to piloting. The pilots for the past series of man powered flights were chosen from among students who held private pilots licences for aeroplanes or gliders.

In 1972, a well-equipped runway, 620 meters in length and 30 meters in width, was completed along with a hanger in the precincts of the Narashino school of Nihon University's Science and Engineering Department. The research base for man-powered aircraft was moved over there. At the same time, model changes were carried out. The new series was named the EGRET, which was supposed to fly better than the LINNET.

The major improvements incorporated in the EGRET series featured introduction of the belt drive to shorten the power transmission system. This was made possible by putting up a pylon for the propeller right behind the cockpit, as seen in the SUMPAC and Jupiter. In keeping with the belt drive, the rear fuselage was elongated and the moment arm was increased for greater longitudinal stability. (The tail volume for the EGRET III was 0.421.)

The II and III models of the EGRET series demonstrated much more stabilized flight characteristics and came out with far better records than the LINNET series. The only exception was the I model which was destroyed on the ground by gusty winds, just after the first flight without any further test results. The 1975 student team was composed wholly of enthusiasts who had been helping their seniors with the manufacture of man-powered aircraft since their freshman days. The team had an expert designer as its leader named Junji Ishii. I decided that I could entrust them with the task of undertaking drastic model changes. We confidently crowned the new model with the name of the Stork which is something of a flier.

Compared with the EGRET, the main thrust of the Stork was directed at further weight

reduction and greater airframe engineering precision (which equates itself with improved aerodynamic characteristics). To achieve these objectives, wholehearted efforts were exerted and exhaustive studies pursued.

The left and right wings were made detachable to facilitate the transport of the airframe on the street. This resulted in a weight penalty of about 2 kg as compared with the conventional one-piece wing. Nevertheless, an overall weight reduction was successfully achieved in terms of an empty weight of 36.0 kg, an incredible figure, while preserving satisfactory rigidity. It is worth noting that in addition to the hitherto used foam plastic panel, "ganpi-shi" (a sort of Japanese paper) was used for the outer cover of the various parts of the airframe. Most important of all, this truly outstanding achievement deservedly owes to the design policy which was attentive to every inch of the airframe and allowed not a single gram of excess weight. The Stork features a longer moment arm than the EGRET series (horizontal tail volume: 0.535), use of the chain drive, instead of the belt, for power transmission (the belt caused troubles because it often got out of place while in driving operation as a result of deflection of the shaft) and a system for driving the wheel while taxiing. In the LINNET and EGRET series, only the propeller was driven.

Since the first flight of 12th March, the Stork A (we call the original aircraft Stork A, whereas the same aircraft with some modifications Stork B) made forty five flights, including eleven ones longer than 400 m.

The flights longer than 400 m of Stork A

Date	Distance (m)	Time (s)	Pilot	Airfield
14 Mar. 1976	446	57	K. Churei	N
14 Mar.	435.5	70	K. Churei	N
15 May	404*	53.0*	K. Churei	S
18 May	470*	57.0*	K. Churei	S
18 May	over 650**	appr. 80**	K. Churei	S
27 May	418	65	K. Churei	N
27 May	507	60	K. Churei	N
28 May	515.6	64	K. Churei	N
2 June	512.7*	68.2*	K. Churei	S
2 June	577.2*	59.0*	T. Kato	S
2 June	595.1*	61.2*	T. Kato	S

Airfield

N: Narashino, Nihon University (Runway 620m x 30m)

S: Shimofusa, Navy Air Base (Runway 2250m x 60m)

* Inspected and measured by the official observers of the Japan Aeronautic Association (a member of F.A.I.)

** These records were not measured accurately, as the flight was made by the pilot's own intension, when the aeroplane was carried along the taxiway after the end of flight tests.

On 4th June, K. Churei, one of our student pilots, accomplished an 180 degree turn for the first time, maintaining a bank angle of 10 degrees and a flying height of 3 m, however, as the turn was progressing, the aircraft fell into the spiral gradually, landing with its left wing tip hitting on the ground. The nose of the fuselage and left wing tip were seriously damaged. As a result of trial, however, we were convinced that we could turn safely if we would maintain much smaller

back angle, turning with longer radius. Thus I was convinced that with the successful debut of the Stork A, the man-powered aircraft of Nihon University have reached the level of their British counterparts for the first time in their 10-year history. The repair and modifications were made on the airframe of the Stork, and now it was named "Stork B". The main points of modifications were as follows:

- (1) The front part of the wing, from the leading edge through the rear end of the main spar was thoroughly waxed, in order to reduce the frictional drag of the wing.
- (2) The rigidity of the steel welded part of fuselage was increased by adding some balsa wood bulkheads between the members of the frame, in order to prevent the deflection of the supports of chain-sprockets, thus increasing the transmission efficiency of man power.
- (3) The outline of the cockpit canopy was changed so as to fit the body form of the particular pilot, T. Kato.
- (4) The movement of elevator was decreased against the amount of the twist of control lever.

Since the first flight of 24 November 1976, the Stork B has made sixty flights by the end of the phase II tests, 4 January 1977, including

Nine flights longer than 800 m

Date	Distance (m)	Time (min-sec)	Pilot	Airfield
26 Dec. '76	816.7	1:57.0	T. Kato	Shimofusa
28 Dec. '76	855.7	1:45.0	T. Kato	Shimofusa
30 Dec. '76	934.5	1:55.0	T. Kato	Shimofusa
30 Dec. '76	1158.2	2:37.0	T. Kato	Shimofusa
30 Dec. '76	982.8	2:09.0	T. Kato	Shimofusa
31 Dec. '76	1487.5	3:52.0	T. Kato	Shimofusa
31 Dec. '76	2074.9	4:43.0	T. Kato	Shimofusa
2 Jan. '77	2093.9	4:27.8	T. Kato	Shimofusa
2 Jan. '77	1455.8	3:27.0	T. Kato	Shimofusa

The flight on 2 January 1977, 2093.9 m distance in 4 min. 27.8 sec., beating the previous record of 1071 metres held by Britain's John Potter, was officially observed by Messrs. Watanabe and Yagasaki, official observers of the Japan Aeronautic Association, a member of F.A.I. Weather conditions for the flight were a temperature of 5°C, 1019 mb pressure, 29 percent humidity and virtually nil wind. Since June last year, Kato, a pilot of 171 cm tall, has trained himself, cycling an equivalent distance of 50 km every day and finally weighted in at 57 kg. He claims that a longer flight would have been possible had he not been restricted by the runway's length.

Specifications of NM-75 Stork.

Type

Single-seat man-powered aircraft

Wings

Cantilever shoulder-wing monoplane. Wing section Wortmann FX61-184 at root, FX-63-137 at tip. Constant-chord, no-dihedral centre-section. Tapered outer panels have 7° dihedral, 8° washout, and 1°53' of forward sweep at quarter-chord. Three-piece wooden structure. Two-spar construction, with spruce flanges and balsa stringers and ribs, covered with styrene paper and Japanese tissue. Rib spacing 100 mm (3.94 in). Conventional ailerons. No flaps or spoilers.

Fuselage

Front portion, including cabin and propeller pylon, is a welded chrome-molybdenum steel tube truss structure, covered with styrene paper and Japanese tissue. Aft portion, square section, is a spruce and balsa truss and is similarly covered.

Tail Unit

Cantilever wooden structure, of similar construction to wings. All-moving horizontal surface of NACA 0009 section; single fin and rudder of NACA 0015 section.

Landing Gear

Non-retractable 686 mm (27 in) diameter bicycle wheel, driven by pedals on ground. No shock-absorbers. Bicycle-type brakes fitted after first flight.

Power system

Man-power on bicycle pedals, transmitted by chain drive to a two-blade all-balsa solid pusher propeller mounted aft of a pylon behind the cabin. Foot pedal rpm 72; propeller rpm 210.

Accommodation

Pilot only, in enclosed cabin, with a specially-designed control bar with a twist-grip at each end (right-hand grip for tailplane control; complete bar pivoted on universal joint for aileron and rudder control).

MAN-POWERED AIRCRAFT OF NIHON UNIVERSITY, 1966 - 76

AIRCRAFT	LINNET I	LINNET II	LINNET III	LINNET IV	EGRET I	EGRET II	EGRET III	Stork A	Stork B
DATE OF FIRST FLIGHT	26 Feb. '66	Feb. '67	26 Mar. '70	13 Mar. '71	28 Feb. '73	30 Oct. '73	16 Nov. '74	12 Mar. '76	24 Nov. '76
MAXIMUM DISTANCE FLOWN (m)	43	91	31	60	34	154	203	595	2093.9
DIMENSIONS									
WING SPAN (m)	22.30	22.30	25.30	25.30	22.70	22.70	23.00	21.00	
LENGTH O.A. (m)	5.60	5.80	5.86	5.80	7.40	7.71	7.70	8.85	
HEIGHT O.A. (m)	4.185	3.52	4.14	4.14	2.29	3.66	3.70	2.40	
TAIL PLANE SPAN (m)	5.40	5.40	5.80	5.91	4.00	5.00	4.70	3.44	
AREAS (m ²)									
WING GROSS (m ²)	26.0	26.0	30.2	30.2	28.5	28.5	28.5	21.7	
ALLERONS TOTAL (m ²)	2.20	-(1)	-(1)	.190	.311	.240	.252		
FIN (m ²)	0.97	0.97	1.53	1.55	0.75	1.04	1.01	0.81	
RUDDER (m ²)	0.46	0.46	0.45	0.45	0.50	0.56	0.76	0.35	
STABILIZER (m ²)	2.18	2.18	-	2.33	-(2)	1.98	2.13	-(2)	
ELEVATORS (m ²)	1.46	1.46	3.40	1.55	3.30	1.32	0.70	1.71	
WING									
AEROFOIL SECTION	NACA63 ₃ -1218	NACA63 ₃ -1218	NACA8418-8415	NACA8418	FX61-184	FX61-184	FX61-184	FX61-184 FX63-137	
WING THICKNESS (%)	18.0	18.0	18.01	15.0	18.0	18.4	18.4	18.4 - 13.7	
ASPECT RATIO	18.5	18.5	21.2	21.2	18.1	18.1	18.6	20.3	
TAPER RATIO	3:1	3:1	3:1	3:1	2.5:1	2.5:1	2:1	2.36:1	
DIHEDRAL	3°	3°	6°	6°	(O.W.) 6°	(O.W.) 6°	(O.W.) 6°	(O.W.) 7°	
PROPELLER									
DIAMETER (m)	2.70	2.70	3.00	3.00	2.70	2.70	2.70	2.5	
RPM	160	200	125	125	180	180	120	210	
SPEED OF AIRCRAFT (m/s)	8.2	8.0	7.6	7.7	8.5	9.6	9.8	8.6	
WEIGHTS									
WEIGHT EMPTY (kg)	50.6	44.7	49.8	55.0	57.0	55.7	61.1	35.9	
FLYING WEIGHT (kg)	108.6(3)	102.7(3)	107.8(3)	113.0(3)	115.0(3)	113.7(3)	119.1(3)	93.9(3)	
WING LOADING (kg/m ²)	4.18	3.95	3.57	3.74	4.04	3.99	4.18	4.33	
WEIGHT BREAKDOWN (kg)									
WING	27.83	19.23	22.0		25.3	24.0	33.0	19.9	
TAIL UNIT	4.03	3.23	3.1		3.0	3.0	2.8	1.0	
CONTROL SYSTEM	0.86	0.96	1.0		5.0	4.7	2.9	7.4	
FUSELAGE	11.90	12.68	12.0		11.5	15.0			
UNDERCARRIAGE	1.55	2.55	3.5		3.0	3.0	1.0		
PROPELLER	1.03	1.3	1.2		1.0	1.4	1.0		
TRANSMISSION	3.66	5.5	5.0		5.0	6.0	5.6		
MISCELLANEOUS	3.65	1.36	1.4		3.0	-	-	-	

(1) no aileron
(2) flying tail
(3) weight of pilot = 58 kg
O.W. outer wing
N.A. no data available

Stork

DIMENSIONS

Wing span	21.00 m	(68 ft 11 in)
Wing chord, centre-section (constant)	1.30 m	(4 ft 3 1/4 in)
Wing aspect ratio	20.3	
Length overall	8.85 m	(29 ft 0 1/2 in)
Height overall	2.40 m	(7 ft 10 1/2 in)
Tailplane span	3.44 m	(11 ft 3 1/2 in)
Propeller diameter	2.50 m	(8 ft 2 1/2 in)

AREAS

Wings, gross	21.70 m ²	(233.6 sq ft)
Ailerons (total)	2.52 m ²	(27.13 sq ft)
Fin	0.81 m ²	(8.72 sq ft)
Rudder	0.35 m ²	(3.77 sq ft)
Tailplane	1.71 m ²	(18.4 sq ft)

WEIGHTS AND LOADING

Weight empty	36 kg	(79.4 lb)
Take off weight	94 kg	(207 lb)
Wing loading	4.33 kg/m ²	(0.89 lb/sq ft)

PERFORMANCE

Optimum speed for long distance flight	16.7 knots (31 km/h; 19.2 mph)
Lift coefficient for above speed	0.94
Estimate power required with ground effects at above speed	0.33 hp at flying altitude of 2m 0.35 hp at flying altitude of 3m

AIRFRAME STRENGTH

Ultimate load factor	2.7
----------------------	-----

Three-view Drawing of Stork A

1. Entire A airframe is covered by Japanese paper (except transparent part of cockpit canopy)
2. balsa strip (1.5 x 5 mm)
3. transparent film of canopy
4. vent for pilot
5. propeller made of laminated balsa wood
6. leading edge covered by styrene paper
7. joint of outer and inner wings
8. leading edge covered by styrene paper
9. detachable canopy
10. balsa (2 x 8mm)
11. balsa (1.5 x 5 mm)
12. trailing edge (balsa, 20 mm wide)
13. fillet made of styrene paper
14. balsa (0.8 x 5 mm, 2 ply)
15. spruce
16. styrene paper (1.5 mm thick)
17. plywood of balsa
18. balsa
19. spar of tailplane (spruce)
20. rib (1.5 x 5 mm balsa)
21. wing tip fairing made of foam-plastics block
22. trailing edge (balsa 15 mm wide)
23. styrene paper (1.5 mm thick)
24. plywood of balsa
25. Japanese paper
26. rib member (1.5 x 1.5 mm)
27. spar flange of spruce
28. balsa
29. balsa strip 0.8 mm thick
30. leading edge (5 mm balsa)
31. rib member (1.5 x 5 mm balsa)
32. balsa
33. hinge line of aileron
34. sections of spar and rib of wing
35. chain
36. saddle for pilot
37. control bar
38. wheel brake
39. fuselage frame, welded chrome-molybdenum pipes (16mm diameter, 0.4mm thick)
40. foot pedal
41. bicycle wheel, 27 inch diameter for road racer
42. fuselage frame
43. laminated member of balsa and foam-plastics
44. 6 piano wires, 1 mm diameter
45. vent for pilot
46. styrene paper (1.5 mm thick)
47. foam-plastics block
48. propeller spinner (monocoque construction of balsa 2 x 8 mm)
49. trailing edge balsa (15 mm wide)
50. auxiliary wheel 32 mm diameter
51. balsa (0.8 x 5 mm 2 ply)
52. spruce
53. wing tip fairing made of foam-plastics block
54. rib of balsa
55. leading edge covered by styrene paper
56. spar of spruce
57. trailing edge (balsa 15 mm wide)
58. leading edge covered by styrene paper
59. skid made of foam-plastics block
60. auxiliary wheel (castor) 20 mm diameter
61. balsa
62. wing tip made of foam-plastics block

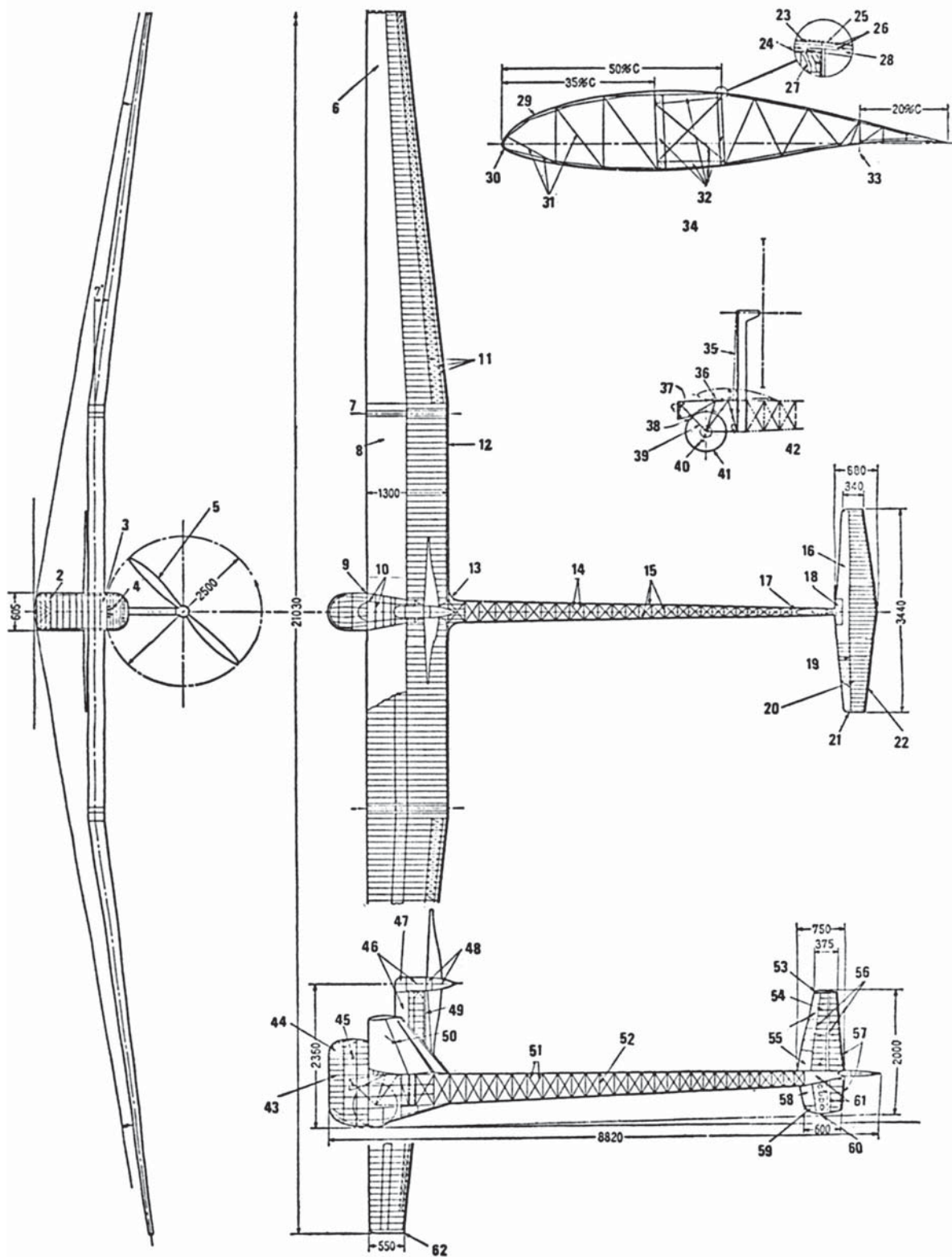

“STORK A”



Test vehicle in 1963, the origin of our man powered aircraft

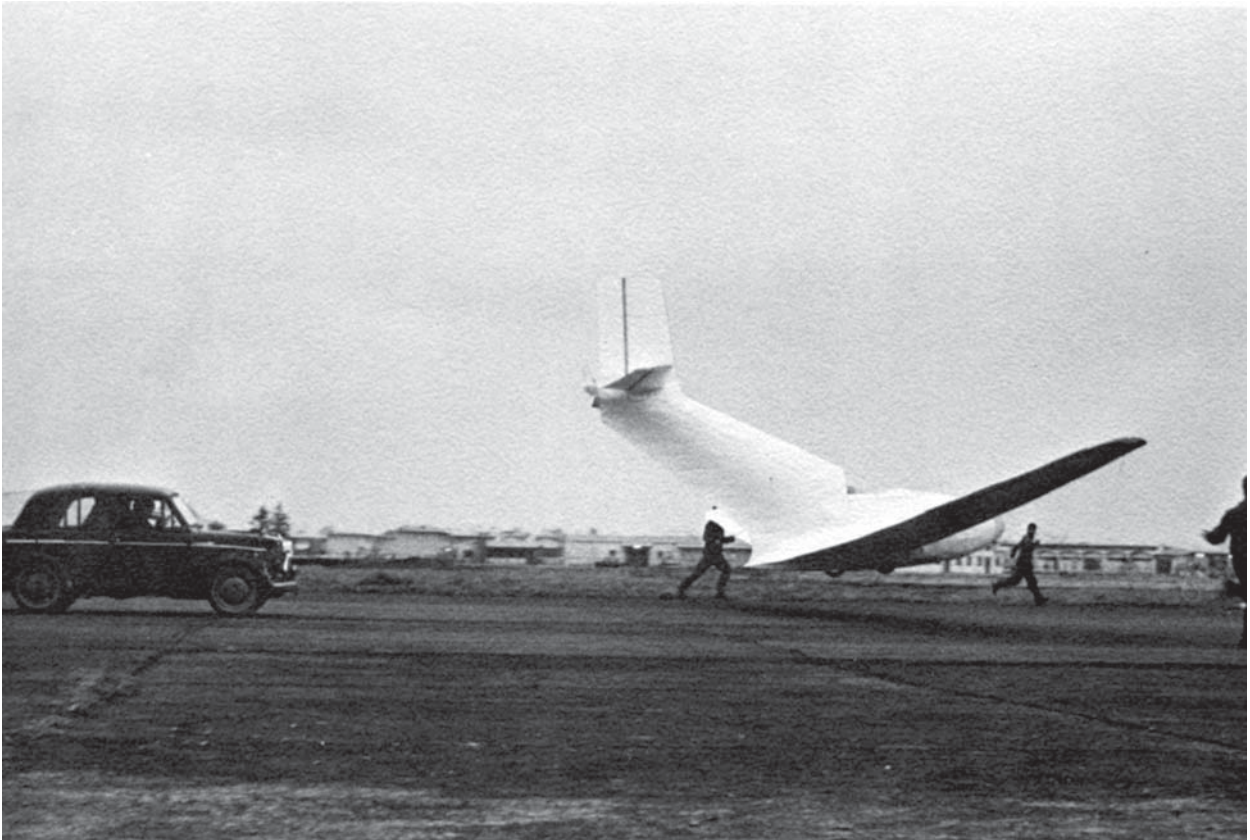

Flight tests of Linnet I, 1966



Flight tests of Linnet II, 1967

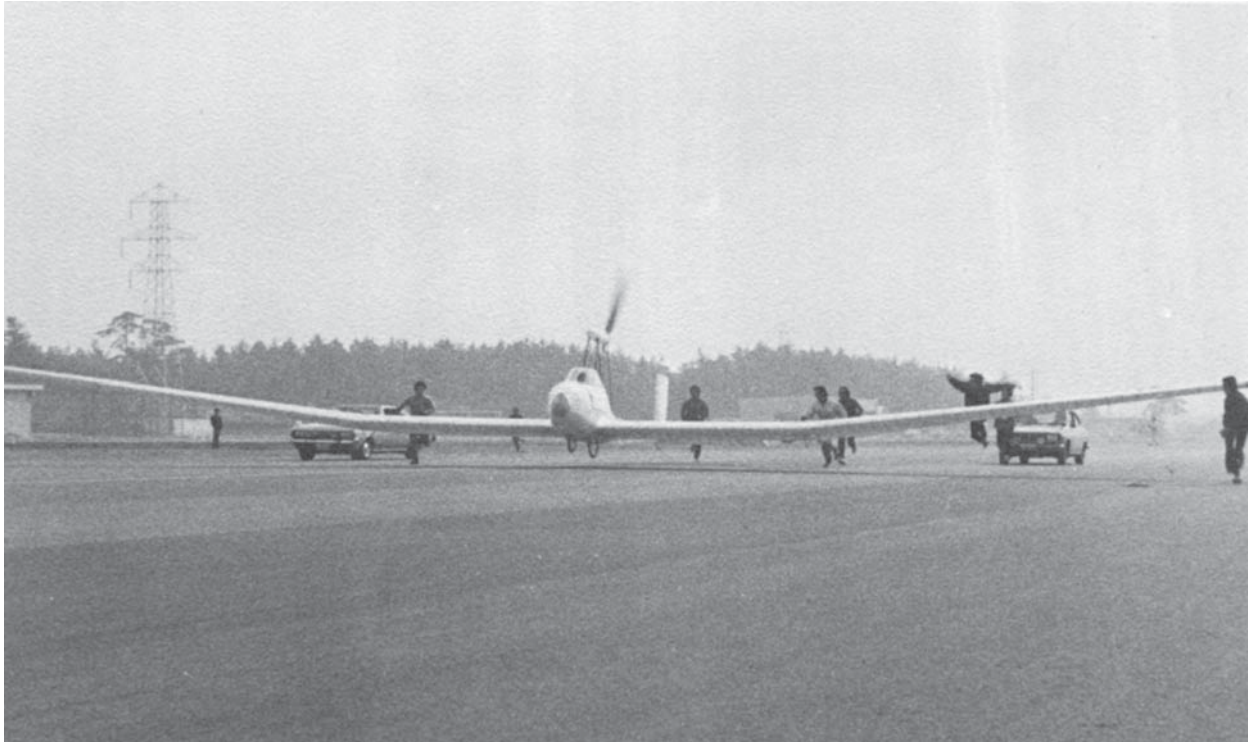

First and last flight of Egret I, 1973



The Egret II in flight, 1973

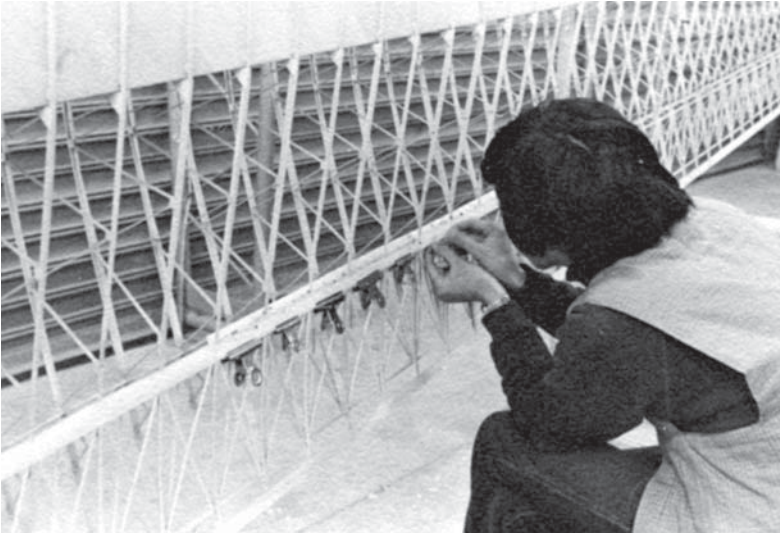

Assembling the wing structure of Stork



Assembly of a wing rib of the Stork

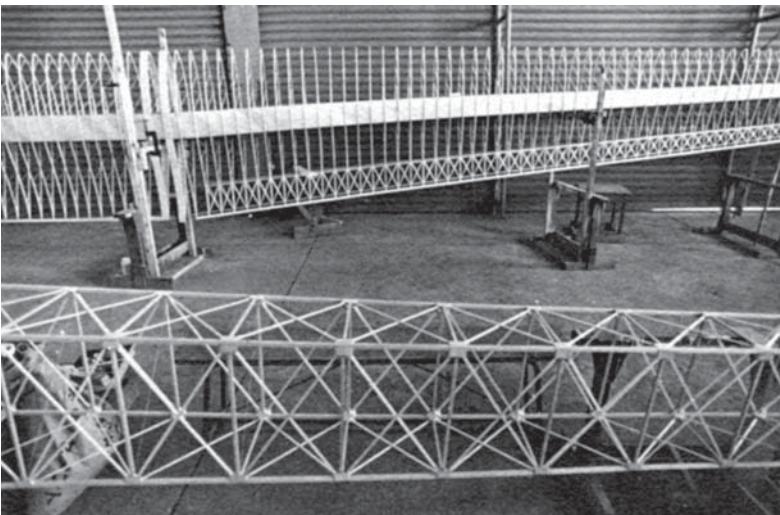

Frame structure of wing and fuselage of Stork

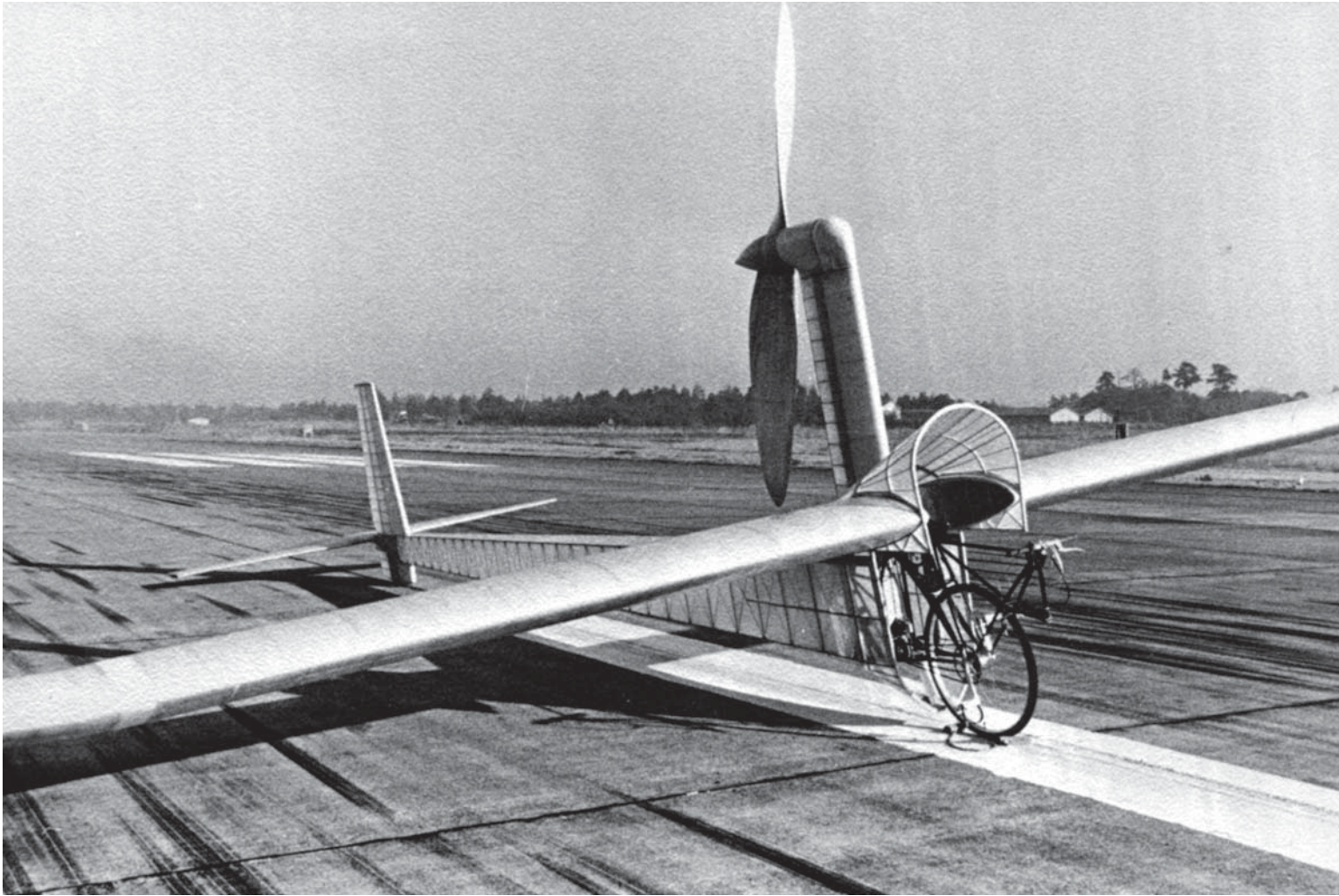

The Stork B without cockpit canopy

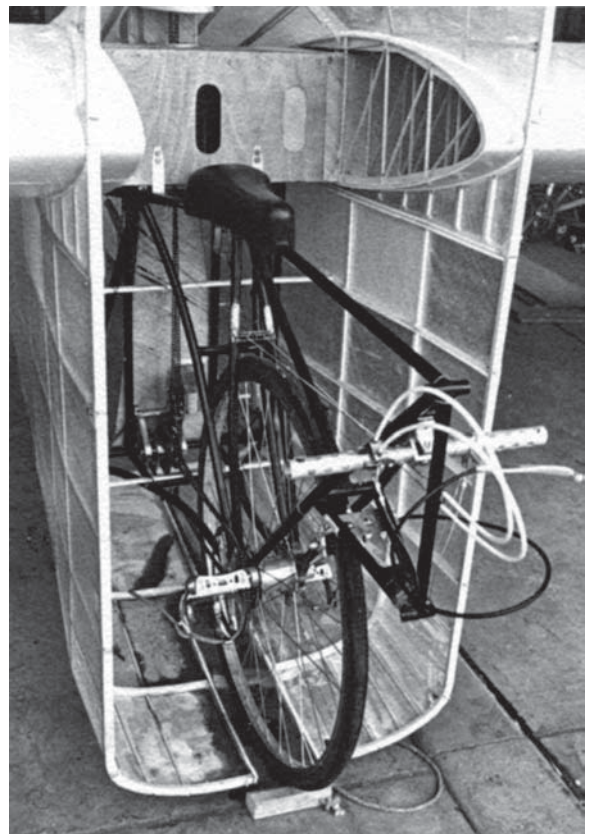

Chrome molybdenum steel frame with control bar, pedals, saddle and wheel

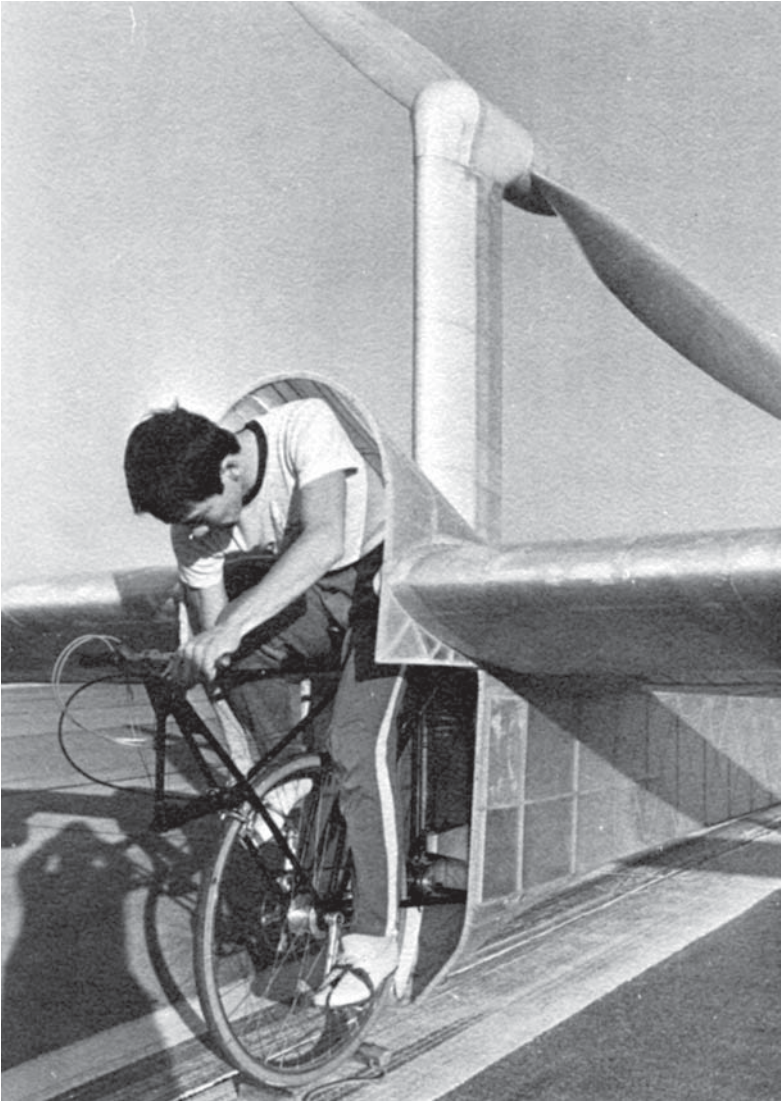

T. Kato one of our student pilots riding on the Stork B



Attaching cockpit canopy

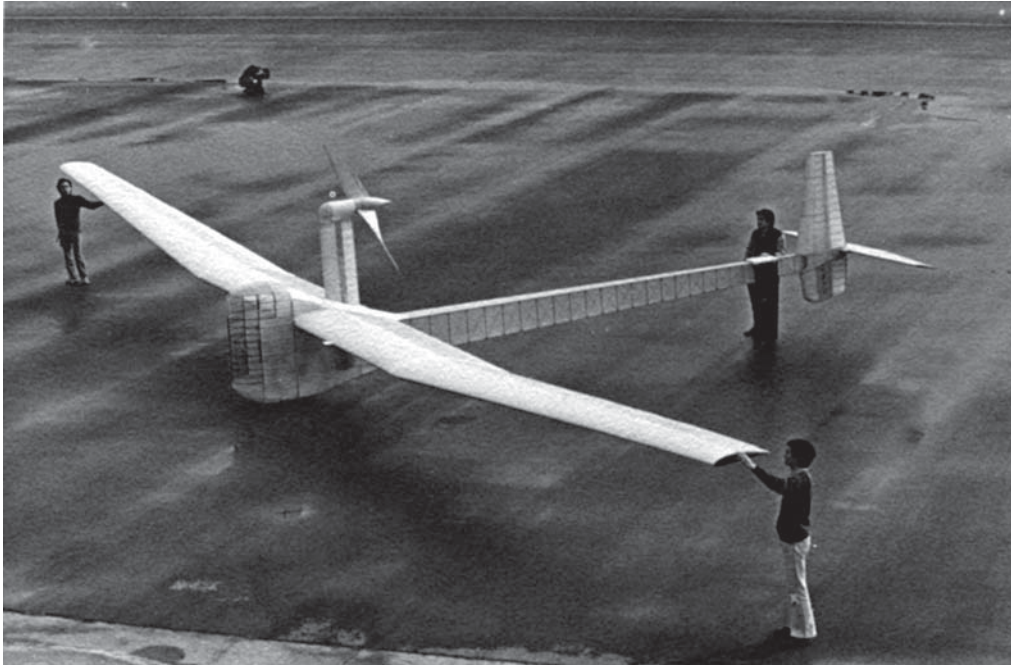

Assembled Stork A

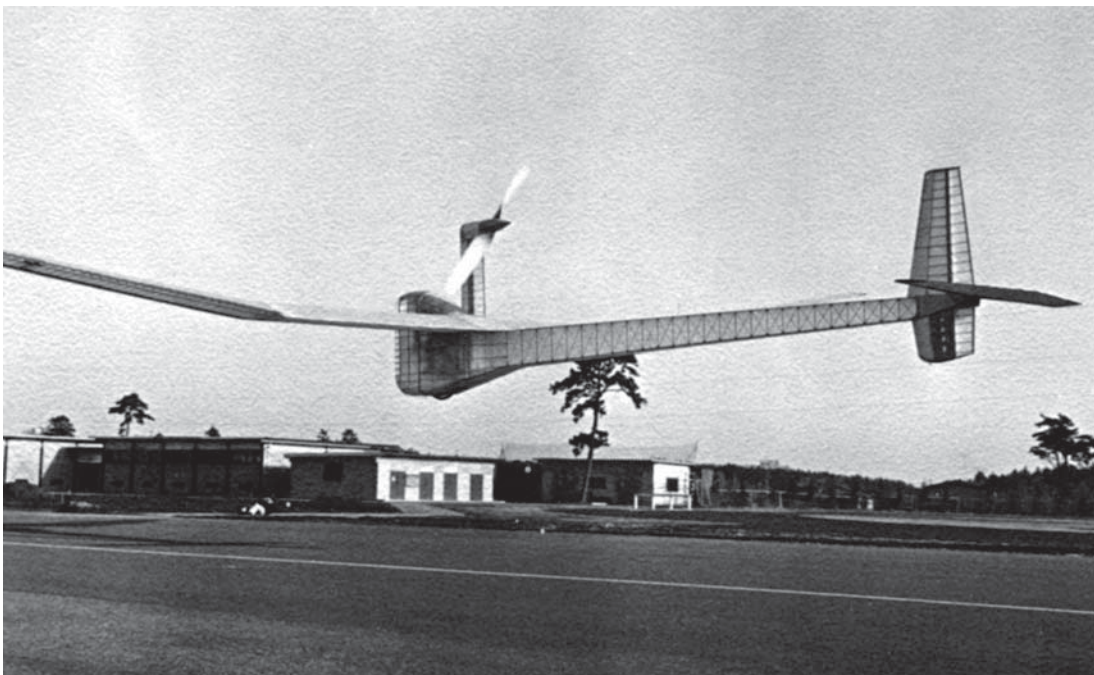

Flight of the Stork A at Narashino runway

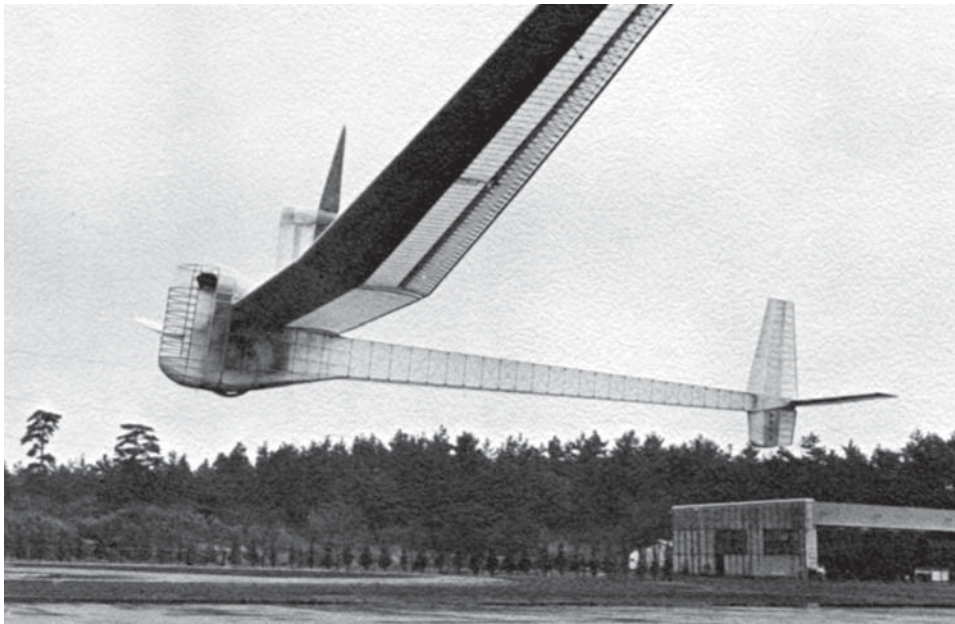

Flight of the Stork A at Narashino runway

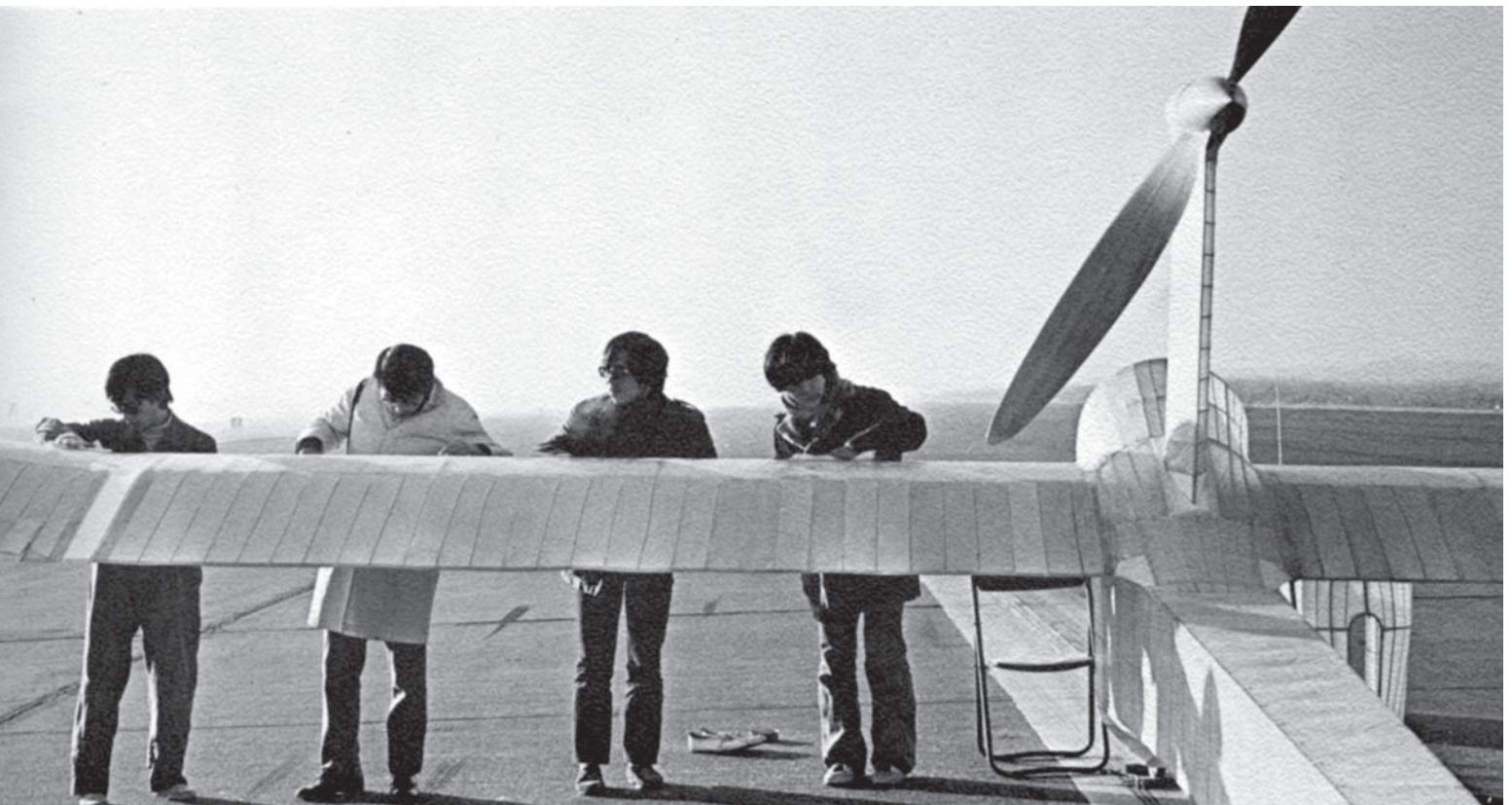

Polishing the upper surface of the wing before the start of flight

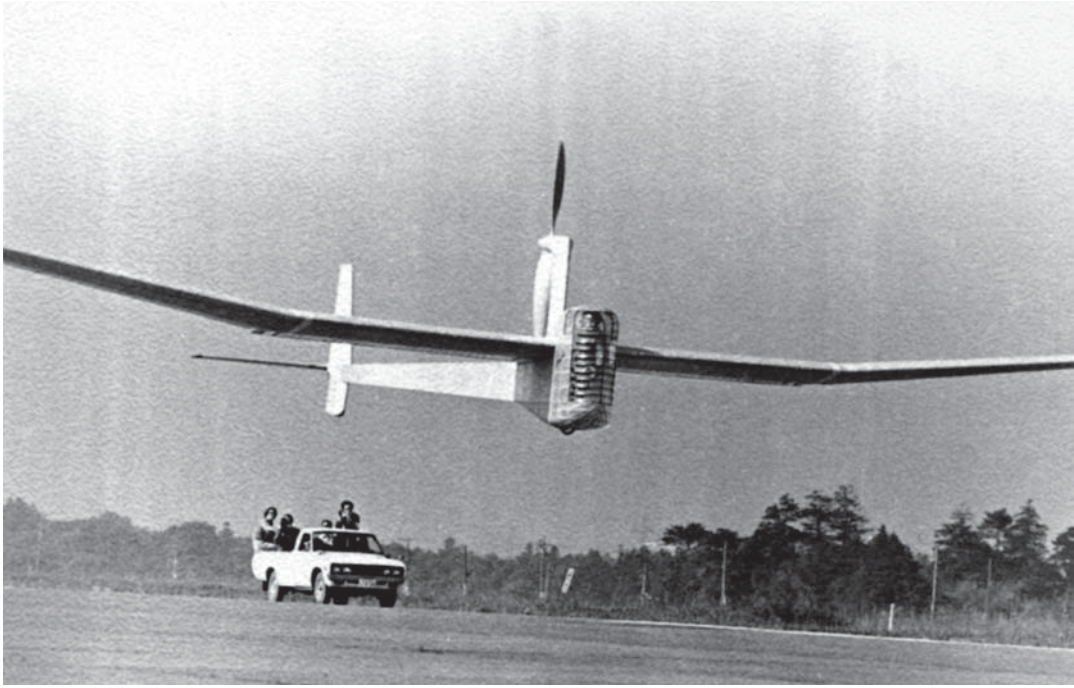

Flight of the Stork B at Shimofusa Naval Air Base

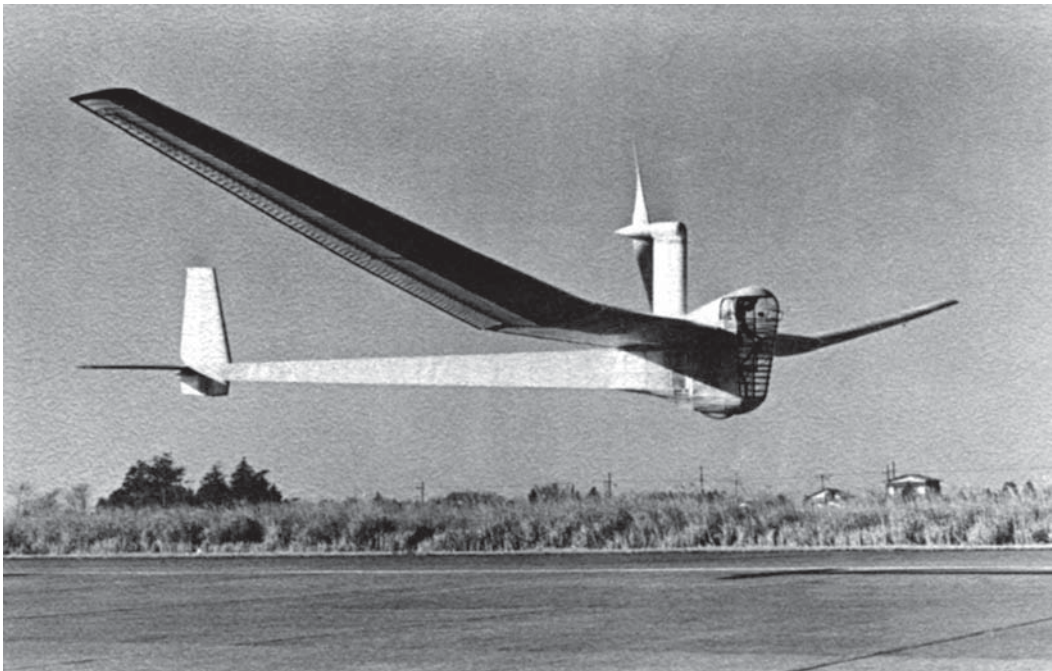

Flight of the Stork B at Shimofusa Naval Air Base

All pictures in this booklet were taken by Mr. Hiroshi Seo

COLLEGE OF SCIENCE AND TECHNOLOGY
NIHON UNIVERSITY
1-8, SURUGADAI, KANDA, CHIYODA-KU,
TOKYO 101 JAPAN