

Man Powered Aircraft Group

The Structural Design and Construction of Man Powered Aircraft

by

M S Pressnell, Hatfield Polytechnic

Paper Presented at the Royal Aeronautical Society Symposium on
"Man Powered Flight - The Way Ahead" held on 7 February 1977.

Royal Aeronautical Society
4 Hamilton Place London
27.4.2007



TOUCAN I airborne at Radlett Airfield where its best flight covered a distance of 700 yards (640 m) in July 1973. It is the only two-seat aeroplane to have flown to date, and the modified aircraft **TOUCAN II** is the largest machine to be constructed, with a wingspan of 139 ft (42.37 m).

1.0 Introduction

1.1 In approaching the design and construction of a man-powered aircraft, one will encounter a multitude of problems of a technical, practical, financial or organisational nature. On reflection the organisational problems are possibly the most demanding, and considering that the construction of a large man-powered aircraft could account for between 10,000 and 25,000 man-hours of work, such a project should not be embarked upon lightly.

1.2 The structural designer may well find himself working on unfamiliar ground, with unusual materials, and with little previous experience to guide him. Certainly he must gain first-hand experience of working with the materials in order to appreciate what is practicable, and there is a case for restraining design to proceed just ahead of construction to take advantage of the feedback of experience.

1.3 The structural designer may find himself acting in the roles of construction instructor, quality inspector and general organiser, and in certain circumstances he should be prepared to grasp these responsibilities in order to see his designs brought to successful fruition. However it is almost too much to expect one individual to be able to give sufficiently freely of his time, or maintain the necessary level of enthusiasm, to undertake this single handed. It is therefore essential for a group to establish individual responsibilities to allow everyone concerned to achieve a maximum satisfaction from their part, at the same time enabling the structural designer to concentrate on his main function.

1.4 In discussing the structural design of man-powered aircraft it is not easy to isolate this topic from the design process which should be conducted in parallel in other areas, notably aerodynamic design and mechanical design. Each designer must have a sympathy for the various requirements of all the design areas, and strive to find a satisfactory compromise where these are in conflict. It is a lack of such appreciation which has led to some of the extraordinary contraptions which have passed as man-powered aircraft.

2.0 Design Load Philosophy

2.1 The aircraft which have flown have clearly established the nature of man-powered flight. In the main they are high aspect ratio monoplanes, of frail ultra-light construction. They fly slowly in close proximity to the ground in very calm conditions, with ponderous directional control. Although this is none too satisfactory, it is all that is possible in the light of the low power available from the human engine, and the current state of the art.

2.2 Flight takes place close to the minimum drag speed of the aircraft, at typically 25 ft/sec (7.6 m/s), which is within 2 or 3 ft/sec (1.0 m/s) of the stall. Faster flight is restricted by the power available. Man-powered aircraft have probably not risen more than 20 ft (6.1 m) above the ground, and from such a height an inadvertent dive would not produce an airspeed in excess of 50 ft/sec (15.2 m/s). Vertical gusts in the close proximity of the ground can be discounted, but horizontal gusts of up to 5 ft/sec (1.5 m/s) can be encountered from any direction in the conditions usually regarded as calm.

2.3 It has been customary to design aircraft for airborne manoeuvres of ± 1 g (unfactored) although there is no record of such manoeuvres having been executed or likely to be necessary.

Indeed man-powered aircraft cannot afford the luxury of being designed to the most adverse conditions which might occur, and as a matter of basic philosophy it is more logical to design to the airborne and ground cases which do occur, but with a more generous factor of safety.

2.4 The control characteristics of man-powered aircraft differ from other types of flying machine, and unconventional control systems and flying techniques are common practice in man-powered flight. The pilot, however experienced on other types, must go through a cautious experimental stage while learning to control the aircraft, and because control forces are small, the full deflection of the surfaces must be anticipated in the air and on the ground.

2.5 Major ground loads arise in the landing manoeuvre and subsequent deceleration. Energy absorption generally depends on the pneumatic characteristics of the tyre and elasticity of the airframe. Typically a rate of descent of 2 ft/sec (0.6 m/s) produces a ground reaction of twice the static load (unfactored). It is important to ensure that the tyre does not bottom on the rim of the wheel, otherwise a severe bump would occur. The wheel rims and large balloon tyres as used on chopper bicycles are very suitable, if the tyre pressure is increased to about 80 psi (550 kN/m²).

2.6 Landing with lateral drift is potentially rather dangerous, an angle of slip up to 1 in 5 being possible. It is advisable to carry out a simple test on a suitably loaded rolling wheel, to measure the side force necessary to produce this angle of slip and to check that the wheel does not collapse. The fitting of brakes is regarded as essential, possibly combined with a lift dumping facility, to enable the pilot to prevent the aircraft inadvertently rolling off the runway.

2.7 Outrigger wheels or skids, fitted beneath the wing for lateral support of the aircraft, are subjected to significant loads. These may be assessed by calculating the rate of roll developed due to a lateral gust without control compensation. The angular kinetic energy is then absorbed by the deflection of the wing under the action of the wheel reactions and inertia forces generated.

2.8 Forces arising in the transmission system may be covered by considering the weight of a man supporting himself on one pedal. This load is quite easily absorbed, but as a precaution against wear and tear the crew should be instructed to limit their effort until the mechanism is working smoothly. It is usual for the main wheel to be driven, as well as the propeller, and in this case snatch loads could arise as the mechanism is accelerated or decelerated as the wheel makes contact with the ground. This is usually avoided by the introduction of free-wheel devices in the system.

2.9 The principal design cases and factors of safety suitable for conventional man-powered aircraft are summarised in Figure 1. In addition ground handling cases as appropriate to each aircraft need to be considered. For example, an aircraft with a nose wheel can be conveniently turned round by pulling down at the tail so that the nose wheel is clear of the ground, and then rotated on the main wheel while slowly rolling forwards or backwards. Another example is the case of a tandem two-seat aircraft; the nose wheel is firstly loaded by ballast to keep it on the ground while the aircraft is empty, and secondly by the front crewman as he boards the machine. The ballast may then be removed and, as the rear crewman boards the machine, the load is transferred to the main wheel. Care must be taken to ensure that wing tip handlers do not attempt to swing an aircraft while nose or tail wheels are on the ground, unless these have a castoring facility.

3.0 Aircraft Flexibility

3.1 A conventional monoplane airframe, designed in accordance with the loading cases described above, will inevitably be very flexible, particularly in respect of wing flexure and to important secondary loading effects, particularly the crushing of the spars (Brazier loading) and rib bending torsion and rear fuselage torsion. Wing flexure gives rise due to the membrane loads in the covering material. Wing trailing edges are particularly vulnerable in the wing down bending case, and even during storage if continuously maintained in compression. The dihedral effect of wing flexure must be taken into account when considering the aircraft stability. A beneficial effect is that the wing tips remain well clear of the ground during turns and in the landing manoeuvre.

3.2 Wing and fuselage torsional flexibilities seriously reduce the effectiveness of conventional aileron and rudder controls respectively. The aileron effect of producing adverse twisting of the wing, and the risk of control reversal, is well known. The rudder effect is peculiar to man-powered aircraft and is related to the direction and magnitude of the tailplane load. If side forces acting on the fin and rudder twist the fuselage, the tailplane load can acquire a significant opposing side component.

3.3 The effects of flexibility are important then, and should be taken into account at the beginning of the design process. In devising the structural layout of the aircraft these adverse effects can be mitigated as well as seeking to minimise airframe weight. This is best explained by reference to a particular aircraft, and Figure 2 illustrates the layout of TOUCAN II, a two seat man-powered aircraft.

3.4 The wing spar position and the torsion bracing are located so that the flexural axis is close to the centre of pressure in cruising flight. The torsion bracing occupies the region ahead of the spar, where it helps to support the most highly loaded part of the aerofoil section. The axis of mass centroids along the wing lays well ahead of the flexural axis which obviates the risk of wing flutter. Slot lip ailerons are used for both roll and yaw control of the aircraft. Their location close to the main spar causes negligible wing twist compared to conventional ailerons.

3.5 The fin, which does not have a rudder, is located above and below the fuselage with the object of limiting rear fuselage torsional loads. Torsional bracing in the lower rear fuselage was necessary to maintain the shape of the uncovered structure. However the Melinex covering, enveloping the large cross-section of the fuselage, provides at least half of the final stiffness. The propeller is located at the rear for aerodynamic reasons, but requires little additional structure there to attain adequate strength and stiffness.

3.6 The fin and tailplane are of symmetrical section, so that their centres of pressure will remain close to the 25% chord position. This is where the spars are located on both components, as well as the hinges for the all moving tailplane. Thus torsional loads are minimised and the Melinex covering alone provides adequate torsional stiffness.

4.0 Weight Prediction

4.1 As with all aircraft, reliable weight and centre of gravity prediction is vitally important, influencing the layout of the aircraft and affecting all subsequent strength and performance

calculations. Sufficient aircraft have been built and flown for target weights to be established on the basis of best current practice. A summary of weight data is given in Figure 3 and wing weights may be compared by reference to Figure 4. A good deal of scatter is apparent, but for future single seat monoplanes of high aspect ratio, wing weight should not exceed 14 lb per 100 ft² (0.68 kg/m²). The Japanese Linnets and M Hurel's machine set this standard, and it is notable that these are largely of wooden construction.

4.2 The experience of two seat aircraft is rather limited, but it should prove possible to better the standard of 10 lb per man per 100 ft² (0.49 kg/m²) which has currently been achieved. In order that optimisation of the wing area and aspect ratio may proceed a more detailed weight breakdown, and its variation with size, must be provided by the structural designer. The data given in Figure 5 may prove useful, being a percentage weight breakdown by component, and by material, for the TOUCAN I two-seat monoplane.

5.0 Structural Influence on Performance

5.1 The equation giving the power required per man to sustain a man-powered aircraft in steady level flight is shown in Figure 6. It conveniently divides itself into three parts which are termed here, the propulsion factor, the structural factor, and the aerodynamic factor. These factors are linked in a complex way through for example, the influence of wing thickness/chord ratio and aspect ratio on wing drag and weight; or the influence of wing deflection on ground effect. All the factors may be traced back to the fundamental choice of aircraft configuration, and choice of materials with their associated construction methods.

5.2 Notwithstanding these complexities, the structural factor provides a basis for the evaluation of the influence of structural design on performance. It combines in an appropriate manner the total weight per man with the wing loading. The structural factors achieved by aircraft which have been constructed are given in Figure 3, and have been calculated by incorporating 150 lb per man. For this reason the total weights used differ in some instances from those published elsewhere, but it is necessary to introduce this standardisation in order that the proper influence of airframe weight is introduced into the comparison.

5.3 The structural factor is plotted against wing area in Figure 7. The lowest values were achieved by the relatively low aspect ratio PERKINS, WRIGHT and MIT machines. Amongst the higher aspect ratio machines, the single seat STORK and HUREL aircraft, and the two seat MAYFLY and TOUCAN aircraft, set the standard. Structural designers of new aircraft should strive to attain structural factors of 200 ft lb^{3/2} (18.68 m kg^{3/2}) or less.

6.0 Airframe Optimisation

6.1 The power requirement may be minimised if the complex interrelationship between thickness/chord ratio, aspect ratio and wing area with airframe weight, profile drag and ground effect can be determined. The results of calculations depend critically on the input of reliable weight data. A weight law can be deduced for each type of airframe if a detailed weight breakdown is available for a datum aircraft.

6.2 As an example of this approach, let us consider the case of a two-seat monoplane, using TOUCAN I as a proven datum. The variation of the weight of each component must be studied

and it can be deduced for the wing that:

| | |
|----------------------------|--|
| Component Weight | Varies in proportion to:- |
| Wing spar flanges | $(\text{Aspect ratio})^{3/2} \times \text{Area}^{1/2} \text{ t/c ratio}$ |
| Leading & trailing edge | $(\text{Aspect ratio})^{1/2} \times \text{Area}^{1/2}$ |
| Spar web & stiffeners | Area x t/c ratio |
| Wing ribs | $(1/2 \text{ as area} + 1/2 \text{ as (area x t/c ratio)})$ |
| Torsion bracing & covering | Area |

The wing spars are stressed essentially by the weight of the crew and fuselage, which may be regarded as constant for a small extrapolation. The variation of wing weight is shown in Figure 8. It is seen that it varies rapidly with area and aspect ratio but slowly with thickness/chord ratio. As thickness/chord ratio is reduced, the spar flanges increase in weight, but this is offset by the reduction in weight of the spar web and ribs.

6.3 The wing tip deflection, which is probably important with respect to ground effect (see heading photograph), is related to the total weight of the aircraft to be lifted and the relief due to the wing weight. In addition the deflection is proportional to:-

$$(\text{Aspect ratio})^{3/2} \times \text{Area}^{1/2} / \text{t/c ratio}$$

The variation of wing tip deflection so calculated is given in Figure 9, where it is seen that it varies slowly with wing area and thickness/chord ratio, but rapidly with aspect ratio. Wing tip deflections of 12 ft or more at an aspect ratio of 30:1 may well be regarded as unacceptable, and certainly raise doubts with regard to ground effect.

6.4 In order to proceed to the final stage, certain assumptions have to be introduced regarding the propulsion factor and the aerodynamic factor. It has been found that the optimum lift coefficient at which to fly a man-powered aircraft lies within a small band close to the stall, in the region where the wing profile drag is beginning to rise rapidly. Making the following assumptions then:

| | | |
|--------------------------------|---|----------------------------|
| Lift coefficient | $C_L = 1.0$ | |
| Induced drag factor | $k = 1.02$ | for datum aircraft |
| Ground effect factor | $g = 1.38 (h/b)^{0.43}$ | after Hoerner |
| Extra to wing drag | $C_{D0} = 0.005$ | for datum aircraft |
| Wing profile drag coefficient | $C_{D0} = 0.008$ | for datum aircraft |
| Variation of profile drag | $C_{D0} (t/c)^{0.4} / \text{Re}^{0.24}$ | after Wimpenny |
| Transmission & prop efficiency | 0.8 | Transmission and propeller |

The variation of power required in ground effect at 12 ft altitude, and out of ground effect, is given in Figure 10. It is seen to reduce steadily with increasing wing area, to $g = 1.38(h/b)^{0.43}$ after Hoerner, and to show an optimum aspect ratio of about 30:1 in ground effect.

6.5 Ground effect is of course most important to man-powered flight, and it is unfortunate that the only data available on this is based on rigid wing theory. One can have confidence in the results at lower aspect ratios, for which wing tip deflections are small, but at an aspect ratio of 35:1 the 'out of ground effect' result may be nearer the truth. If this were the case the optimum aspect ratio could be 20:1 with little loss in choosing 15:1 or lower. The effect on aircraft con-

figuration, handling, and controllability would be most beneficial, and aerodynamic research into this field is highly desirable.

7.0 Choice of Materials

7.1 Man-powered aircraft are usually designed with the intention of constructing only one, but experience is that some unforeseen accident makes a major rebuild necessary - with the opportunity for improved design. Aircraft are comparatively cheap (material costs circa pounds 1000), largely because labour is generally free within the Group. Costs are therefore not a constraining factor unless components in small quantities are sub-contracted. This is often avoided by improvisation; TOUCAN contains components adapted from Victor, Herald and Jetstream aircraft.

7.2 Aircraft use a range of materials, selected for their intended purpose on the basis of their relative strength, stiffness, density, availability, and ease of working when manufacturing facilities are limited. Indeed all the usual reasons, except that environmental factors such as fatigue or corrosion resistance are of less importance than in other aeronautical applications.

7.3 Figure 11 summarises the properties of a range of materials arranged in sequence of density. The lightest materials are the foamed plastics of which expanded polystyrene is attractive because of the ease with which it can be cut with a hot wire from readily available block or sheet. It is most suitable for low stressed components where its low density and ease of working are the principal considerations, such as areas requiring smooth surfacing, leading edges, formers, fairings; and for the sandwich construction of items such as trailing edges or propellers with balsa sheet covering.

7.4 A good deal of the lightly loaded structure is sized by consideration of minimum practical scantlings, when the local bending or buckling strength becomes paramount. For solid sections, soft balsa wood is the superior material. Balsa wood comes in a wide range of density and quality and must be carefully selected for straightness of the grain, freedom from compression shakes, wood worm etc. It is suitable for tailplanes, fins, control surfaces, wing ribs, fuselage frames, and where light laminated shapes are required. Its variation in density and strength in proportion, can be turned to advantage. TOUCAN tail and fin spars are constant in size from root to tip, but vary in strength 6:1 in sympathy with the applied loading. Balsa wood is prone to expansion or contraction with changes of humidity, and thin sheeted surfaces are generally unsatisfactory, either buckling across the grain or splitting along it.

7.5 For highly loaded structural components with uniaxial stress, such as wing spar flanges and longerons, spruce cut and inspected in accordance with aircraft practice has proved popular. It has a specific tensile strength comparable to the metals, but with its lower strength the cross-sectional areas required lend themselves to solid sections. These can be tapered in accordance with the loading almost at will, and present adequate surface area for the glueing of adjacent components. Wood is a virtually non-ductile material, although it does creep under sustained stress, which together with its relative weakness across the grain, puts a premium on the quality of detail design. Metal attachments to wooden components should be tapered to promote a uniformly low stress in the joint. Redux bonding is preferable to bolted attachments, although some aluminium alloy bolts carefully placed, can be justified to resist peeling effects in the bond.

7.6 Birch plywood is available in thicknesses down to 1 mm. Although the lightest spar webs

have probably been designed as braced frameworks, using balsa and/or spruce posts and diagonals, the multitude of joints in such primary structure gives rise to concern. A thin plywood web, with its face grain at 45 degrees to the spanwise axis of the wing, giving the greatest resistance to shear buckling and with vertical balsa stiffeners, provides better structural integrity with easier construction. Thicker plywood, used in small quantities is useful for major wing ribs and fuselage frames, where holes for bolts, or to retain bearings, or for lightness, may be incorporated.

7.7 Weldable magnesium alloy or aluminium alloy tube is useful for crew support structures, although such materials are relatively soft and weak. Geometrical difficulties in this region are acute, and some designers show a preference for fabricated thin sheet structures which the crew sit astride. Square or rectangular section tubes can be up to 4 in (100 mm) wide without discomfort to the legs, although protection against abrasive edges and protruberances is necessary. Aluminium alloy sheet in 30 S',JG (0.31 mm) can be worked, but with considerable risk of parting. Solid aluminium alloy rivets do too much local damage to the thin sheet, although hollow rivets of the Chobert type (unplugged) have been used successfully, although it is laborious. Spot welding is an attractive alternative if the equipment and expertise are available.

7.8 Titanium or aluminium alloy tubular spars have been given consideration, and at least one aircraft MERCURY, has been constructed with the latter. The result was not conclusively encouraging (ref Figure 4) and many constructors would experience difficulty in obtaining the very thin walled tube required for efficient design. It can be produced from thicker tube chemically etched to the required thickness, which can be varied in steps to suit the loading. Great care is required to prevent local denting of the thin tube.

7.9 Titanium is particularly attractive for highly stressed components such as major attachment pins. These can be turned from standard bolts and may be hollowed. Steel should be used very sparingly, although in the Dower transmission. system efficiency must not give way to excessive weight saving. Thus lightweight ball and needle bearings are justifiable, as are commercially available steel wheel rims and spokes. Aluminium alloy chain drives, similar to steel bicycle chain, together with tools to cut corresponding aluminium alloy sprocket wheels, are available. The rate of wear can be tolerated, and the chain runs, if of sufficient length, may be twisted to change the direction of motion between, for example, the pedal cranks and the propeller shaft. Stranded, stainless steel wire of small diameter (1 mm) is suitable for control runs, and used with PTFE guides and fairleads instead of pulleys, provides a light, stiff system without undue friction.

7.10 Carbon fibre, as a relatively new material, has not been exploited in those aircraft which have flown, although at least one is under construction (MICRON). While it may not be suitable for use alone in the very small cross-sectional sizes which appertain, it has possibilities as reinforcement to expanded polystyrene, balsa wood and spruce components. Its value can only be properly assessed by reference to practical experience, and some experimental design and tests of wing ribs are discussed in a later section of this paper.

8.0 Detail Design and Construction

8.1 Notwithstanding all that has been said, the success or failure of a man-powered aircraft will depend crucially on the quality of detail design and construction. While attention to every detail is necessary, the burden of drawing can be minimised. Typically an aircraft can be drawn on about fifty sheets, mainly as dimensioned assemblies and geometries with some detail draw-

ings. In some instances the details need only be drawn directly on to the flat benches or formers on which components are to be assembled. Although communication between designers and constructors is vital, they may be the same people, and the extent to which formalised communication is necessary may be reviewed on its merits.

8.2 The sequence of construction can be chosen with some advantage. Development problems with mechanical systems should be anticipated, and the crew support structure with most of the mechanical parts and even the propeller is a candidate for early construction. This enables test and development to commence while other components are still under construction. Wing assembly is the stage requiring most space and this may need to be the last item of construction, except for the covering.

8.3 Provision for adjustments needs to be incorporated in the design, the items most likely to be affected are; wing incidence; wing dihedral; the relative position of pedals, seats and controls; control surface position, and cable pretensioning; gearing between pedals, road wheel, and propeller; and propeller pitch. The assembly and rigging of a man-powered aircraft can take as long as three hours, in which time weather conditions can change drastically. Where possible derigging the aircraft should not breakdown control circuits to the extent that they need readjusting and pretensioning on reassembly.

8.4 Major attachments can present severe operational problems. If redundant force systems are contained within the joint, structural deformation will affect the alignment and in some circumstances the joint cannot be assembled. This occurred on MAYFLY, where the local stiffness of the fuselage depended on it being attached to the wing. Figure 12 illustrates the complexity of the force systems occurring at the wing/fuselage intersection of TOUCAN. The wing is attached to the crew support frame by the statically determinate load paths W1, W2, W3, W4, W5 and W6. The rear fuselage is attached to the wing and crew support frame by the statically determinate load paths R1, R2, R3, R4, R5 and R6. In addition wheel loads M1, M2, M3, N1 and N2, crankloads C1, C2, C3 and C4, saddle loads S1 and S2, and transmission forces T1, T2 and T3 must be accommodated.

8.5 Detail design and construction is not a subject on which one can generalise at length, and specific case studies are far more informative. For this reason a selection of photo graphs and explanatory captions can be found at the end of this paper. These show aspects of the construction of the TOUCAN two-seat aircraft at Radlett Airfield.

9.0 Rib Tests to Evaluate Carbon Fibre

9.1 As a part of an Aeronautical engineering undergraduate student's final year major project, at the Hatfield Polytechnic, five rib designs have been constructed and tested. These are based on the FX63137 wing section and represent the structure between the main spar assumed to be at 30% chord, and the trailing edge commencing at 80% chord. A photograph of the ribs and test loading arrangements is presented overleaf on pages 13 and 14.

9.2 Lightweight rib design depends initially on a judgement of the minimum material sizes which may be employed for each part, followed by strength testing to determine the maximum pitch of rib which would be acceptable within the wing. Other constraints, such as aerodynamic shape, may then influence the choice of rib pitch, and incur a weight penalty. The ribs designed and tested are briefly described as follows:-

(a) A balsa braced framework, using 1/4" x 1/8" section outline and diagonals with 1/4" x 1/16 I-section overlapping vertical posts.

(b) Similar to (a) above but with the introduction of carbon fibre reinforcing of the top and bottom edge members (50,000 filament tows).

(c) expanded polystyrene 1/4" thick rib web, reinforced at the top and bottom edges by 1/4" x 1/8" balsa wood.

(d) expanded polystyrene 1/4" thick rib web, reinforced on each side at the top and bottom edges by carbon fibre (50,000 filament tows).

(e) Expanded polystyrene 1/4" thick rib web, with 1/4" x 1/16" balsa top and bottom edges reinforced by carbon fibre (50,000 filament tow).

9.3 The ribs were loaded through a tree system approximately representing a distribution of loading increasing linearly from the trailing edge. The compression flanges of the ribs were partially stabilised against lateral buckling in a manner representing aircraft practice. The results are summarised in the table below:-

| RIB | | (a) | (b) | (c) | (d) | (e) | (e) mod |
|-----------------|--------|-------|-------|-------|-------|-------|---------|
| Balsa | lb | .0477 | .0466 | .0119 | - | .0108 | .0108 |
| Polystyrene | lb | - | - | .0392 | .0365 | .0350 | .0284 |
| Carbon Fibre | lb | - | .0065 | - | .0077 | .0055 | .0055 |
| Total Weight | lb | .0477 | .0531 | .0511 | .0442 | .0513 | .0447 |
| Strength | lbf | 11 | 17 | 16 | 17 | 16 | 16 |
| Strength/weight | lbf/lb | 231 | 320 | 313 | 158 | 312 | 358 |

9.4 Rib (a) failed initially at 11 lbf by fracture of the tension flange at its point of greatest curvature. The flanges of rib (b), reinforced by carbon fibre, did not fracture, failure occurring at a joint in the balsa bracing at 17 lbf. These types of rib are time consuming to construct and require some expertise.

9.5 Rib (c) by comparison was simple and quick in construction. It failed at 16 lbf by lateral buckling of the compression flange. A weight saving could have been made by introducing lightening holes in the web. Rib (d) failed at only 7 lbf when the carbon fibre compression flange crippled locally at a small void between beads of the expanded polystyrene.

9.6 Rib (e) was loaded to 16 lbf when signs of imminent collapse of the compression flange by lateral buckling were observed. It was then modified by progressively introducing lightening holes in the polystyrene web, which finally failed by tearing at a hole at 16 lbf.

9.7 The following conclusions arise from these tests:

9.7.1 Thin carbon fibre tows stabilised by low density expanded polystyrene is an unreliable mode of fabrication.

9.7.2 The ultimate design rib load is about 6 lbf/ft run spanwise, so that the structurally acceptable rib pitch is large. It will need to be determined on aerodynamic considerations.

9.7.3 The difficulty of designing down to the ultimate loading is apparent. The use of carbon fibre did not lead to lighter ribs.

9.7.4 The most satisfactory rib design evolved would have balsa flanges and an expanded polystyrene web with lightening holes.

10 General Conclusions

10.1 The structural designer has an important role to play in the continuing development of man-powered flight. That role must embrace practical study in combination with theoretical work.

10.2 Structural design should not proceed in isolation of aerodynamic and other considerations. Many of the problems on both the small and large scales occur at the interfaces.

10.3 The use of carbon fibre in wing spar design, and other areas of high loading, looks most promising. It is likely to lead to stiffer wings which, with large aspect ratio, can make better use of ground effect.

10.4 Further research is necessary in the areas of structural design and flexible wings in ground effect.

11 Acknowledgements

The author wishes to acknowledge the kind cooperation of the following individuals and organisations which have made it possible to present this paper to the symposium:-

- 1 The Hatfield Polytechnic Computer Centre, typing, tracing and reprographic services.
- 2 Mr R F Lambert of the Hertfordshire Pedal Aeronauts for the provision of photographs of TOUCAN
- 3 Mr D Lovell, Project Manager, Morganite Modmor Ltd, for information and advice on carbon fibre.
- 4 Mr D D Ateh, undergraduate student at the Hatfield Polytechnic for rib construction and testing.

Fig 1: Summary of Principal Design Cases

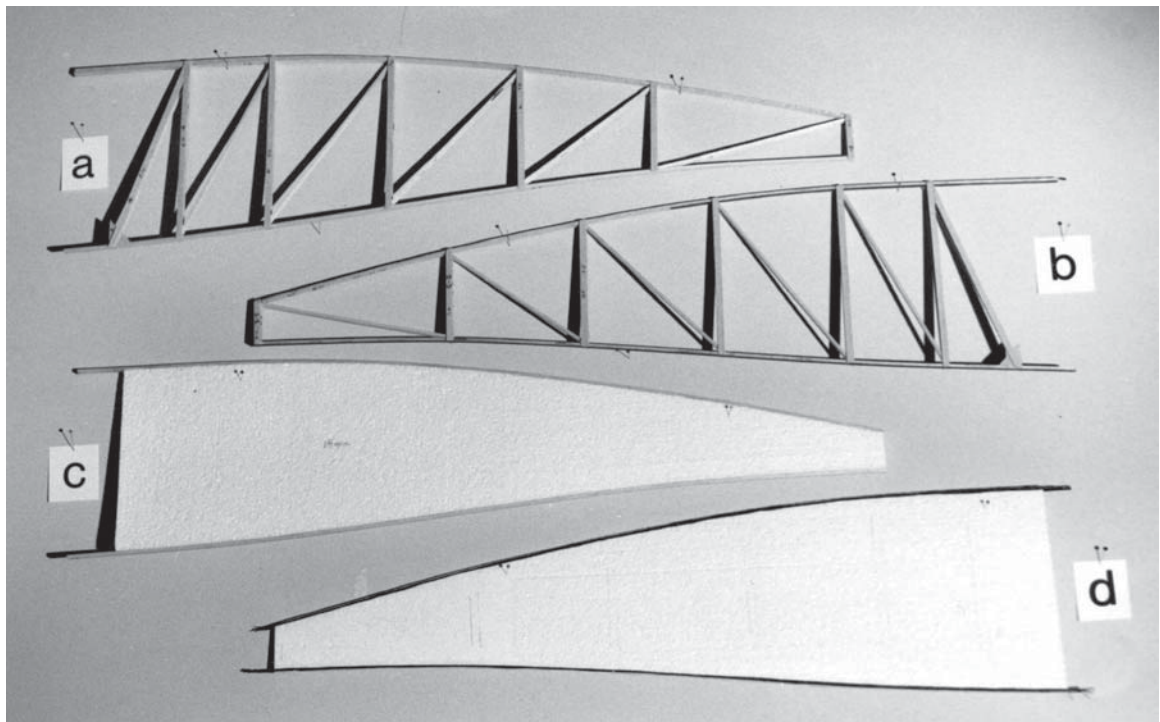

Experimental ribs suitable for a single seat aircraft. Total chord 1.5 m

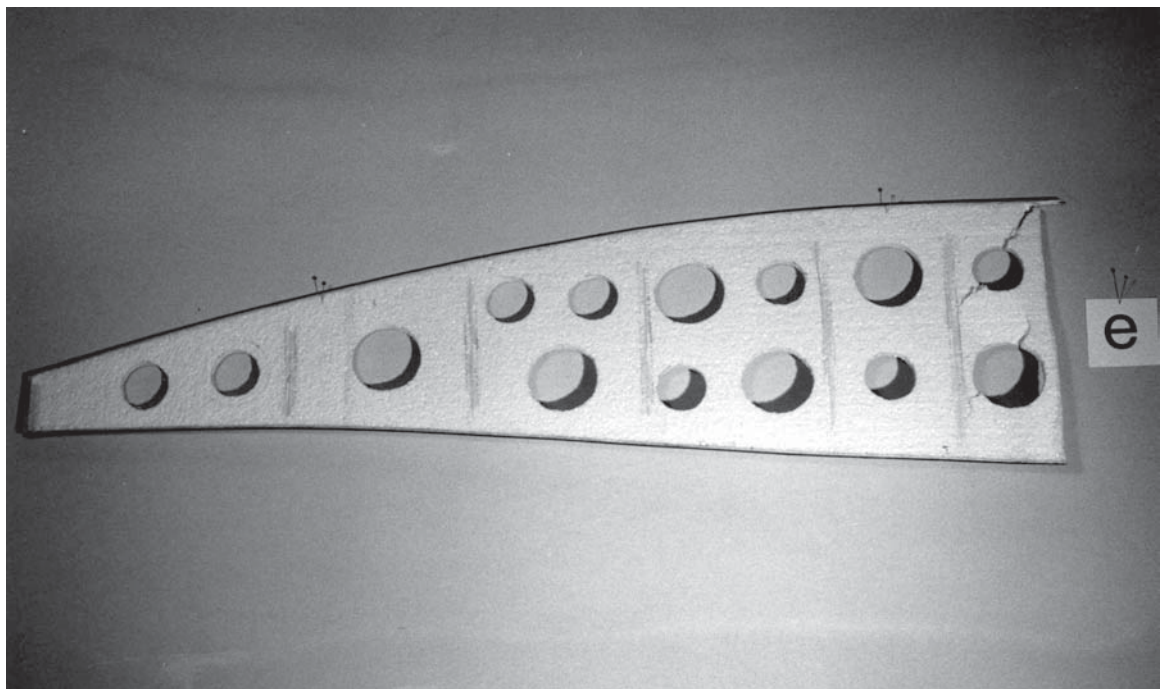

Rib (e) after modification by the introduction of lightning holes

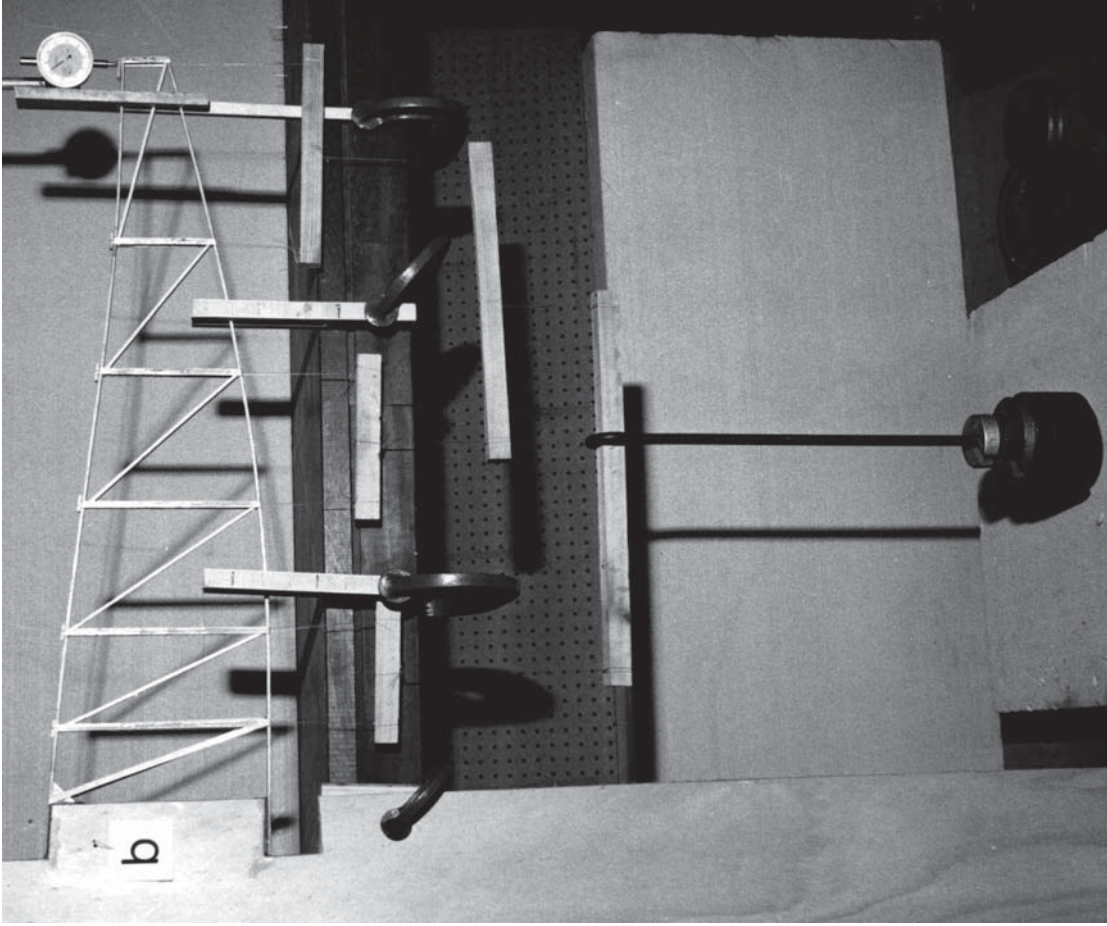

Method of loading the ribs in the test

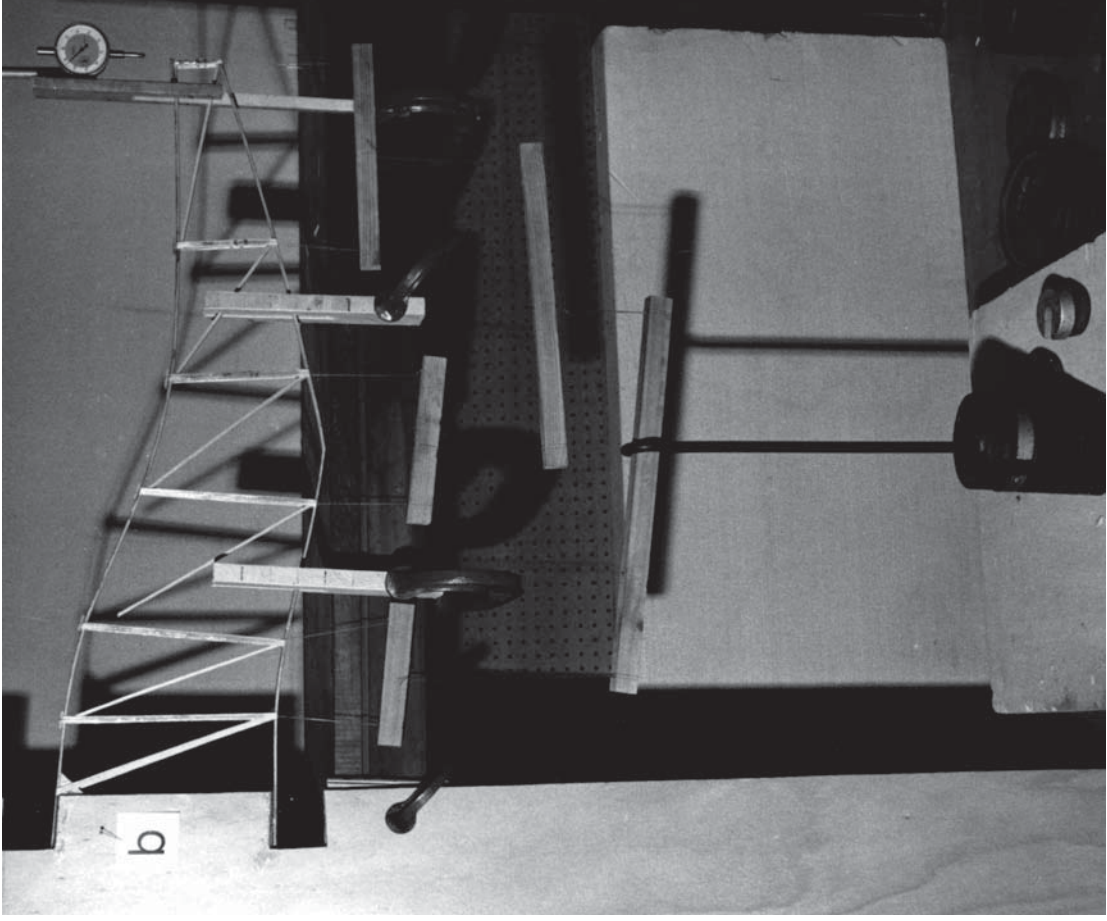

Rib (b) following failure of a joint in the shear bracing

| Aircraft Component | Design Case |
|--------------------------------|--|
| Wing spars, ribs, etc up loads | Level flight at $V_c + 5\text{ft/sec}$ gust |
| Wing spars, down loads | Static load + 5 ft/sec gust |
| Aileron & wing bracing | Full deflection at $V_c + 5\text{ft/sec}$ gust |
| Outrigger & wing bracing | Lateral drift landing 1 in 5 |
| Wing torsion bracing | Max ground speed + gust at zero lift |
| Fin & rudder | Full deflection at $V_c + 5\text{ft/sec}$ gust |
| Tailplane & elevator | Full deflection at $V_c + 5\text{ft/sec}$ gust |
| Main undercarriage wheel | 2 x static load with side force |
| Rear fuselage | Fin, tailplane & U/C cases combined |
| Mechanism | 100 lbf pedal force |
| Crew support frame | Critical cases from those above |
| Ribs, trailing edges, controls | A/C stationery. 5 ft/sec tail gust |

Notes

- 1 Additional ground handling cases should be considered as appropriate to each aircraft.
- 2 Each case above, taken with an ultimate factor of 2.0, may be considered to cover proof strength requirements, as well as other cases less likely to occur.
- 3 For main attachments an additional factor of 1.25 is recommended to cover wear and tear.
- 4 The cruising speed V_c is typically 25 ft/sec, and the maximum ground speed could be taken as 30 ft/sec.

Fig. 2 HERTFORDSHIRE PEDAL AERONAUTS TOUCAN II

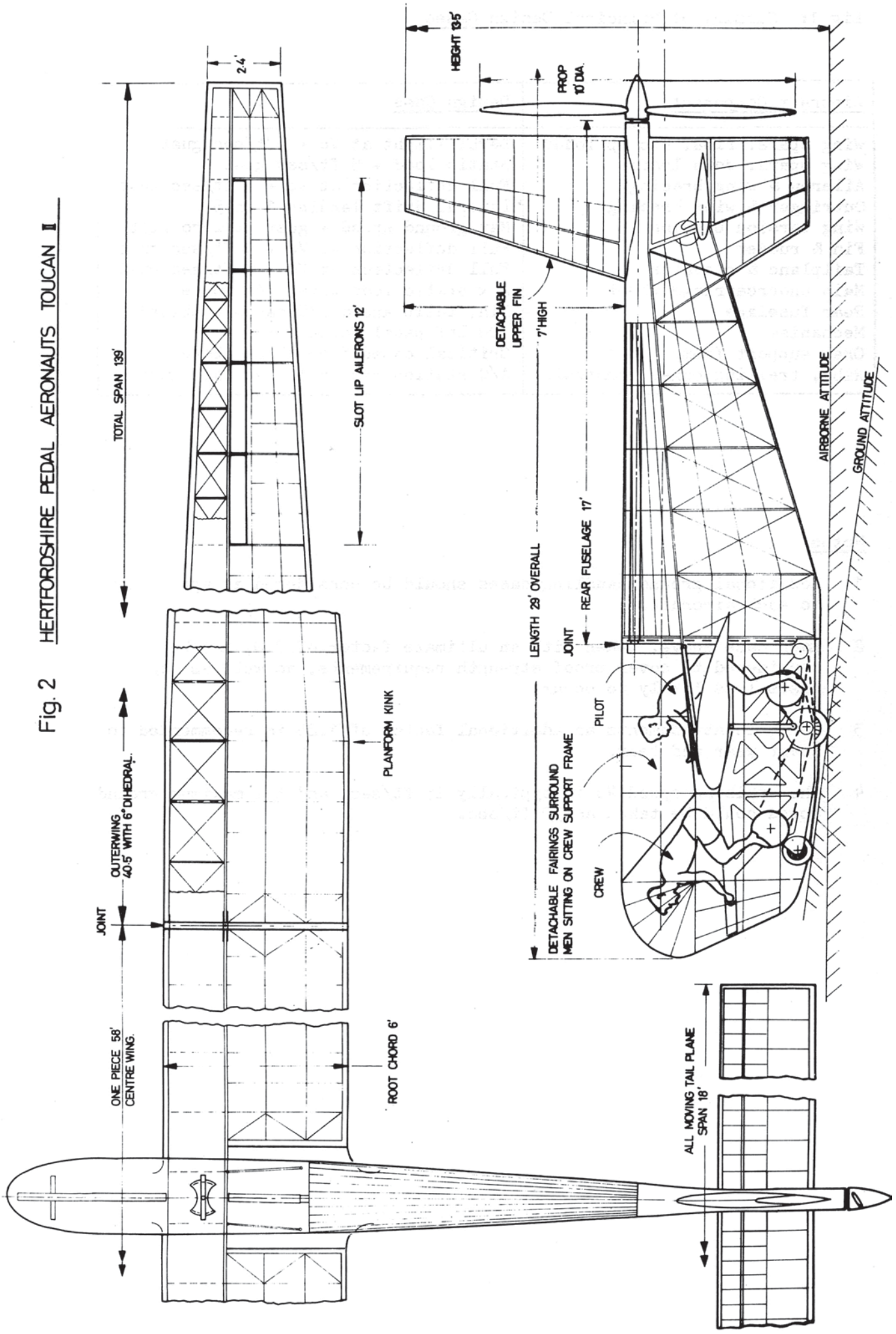

| Aircraft | | Wing Span ft | Wing Area ft ² | Aspect Ratio | Wing Weight lb | Empty Weight lb | Structural Factor ft lb ^{3/2} |
|----------------------|----|--------------------|---------------------------------|-----------------|----------------------|-----------------------|--|
| SUMPAC | | 80 | 300 | 21.3 | 79 | 128 | 257.6 |
| Puffin I | | 84 | 330 | 21.4 | 65 | 118 | 241.5 |
| Puffin II | | 93 | 390 | 22.0 | 84 | 136 | 248.8 |
| Liverpuffin | | 64 | 305 | 13.4 | 74 | 140 | 282.8 |
| Mercury | + | 120 | 480 | 30.0 | 75 | 178 | 271.1 |
| Jupiter | | 80 | 300 | 20.7 | 92 | 146 | 294.0 |
| Dragonfly | | 80 | 214 | 30.0 | 54 | 95 | 262.0 |
| Perkins (Inflatable) | | 33 | 250 | 4.4 | 13 | 39 | 164.3 |
| Wright No 1 | | 71 | 480 | 10.5 | - | 90 | 169.7 |
| Mayfly | * | 90 | 400 | 20.3 | 81 | 145 | 234.6 |
| Toucan I | * | 123 | 600 | 25.2 | 125 | 209 | 234.4 |
| Toucan II | * | 139 | 696 | 27.8 | 157 | 241 | 238.5 |
| Phillips | +* | 80 | 300 | 21.3 | - | 95 | 226.6 |
| Haessler-Villinger | | 44 | 102 | 18.8 | 53 | 80 | 345.8 |
| Bossi-Bonomi | | 56 | 230 | 13.4 | 99 | 214 | 457.9 |
| Malliga | + | 64 | 262 | 15.6 | - | 113 | 263.5 |
| Santa-Meada | | 73 | 290 | 17.9 | - | 122 | 263.4 |
| Linnet I | | 73 | 280 | 18.5 | 50.2 | 111.3 | 251.9 |
| Linnet II | | 73 | 280 | 18.5 | 42.3 | 98.3 | 233.4 |
| Linnet III | | 83 | 325 | 21.2 | 48.4 | 109.6 | 232.6 |
| Linnet IV | | 83 | 325 | 21.2 | - | 121 | 247.5 |
| Egret I | | 74.5 | 307 | 18.1 | 55.0 | 125.4 | 260.3 |
| Egret II | | 74.5 | 307 | 18.1 | 52.8 | 122.5 | 257.4 |
| Egret III | | 75.5 | 307 | 18.6 | 72.6 | 134.4 | 273.2 |
| Stork I | | 68.9 | 234 | 20.3 | 43.8 | 79 | 226.5 |
| Hurel | | 132 | 581 | 30 | 79 | 150 | 215.6 |
| MIT (Biplane) | * | 162 | 640 | 112 | - | 130 | 176.2 |

* Two seats
+ Al aly spars

Fig 3: Data for Man-Powered Aircraft Constructed

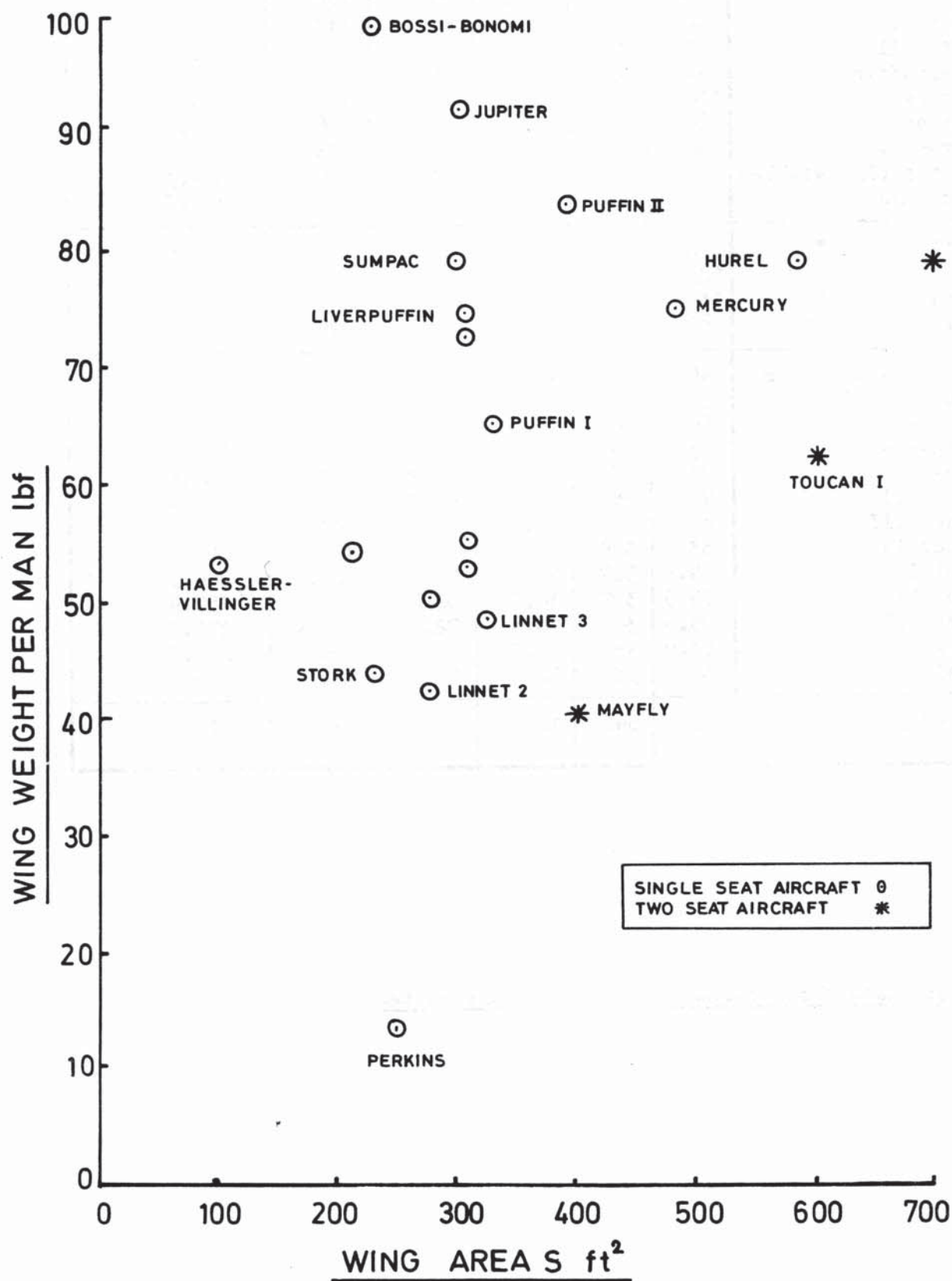

Fig 4: Man-Powered Aircraft Wing Weights

| Material Component | Spruce | Ply 1mm & 1/4" | Balsa | Polystyrene Melinex | Metal (Al. Aly.) | Total % |
|--------------------|-------------|-------------------|-------------|------------------------|---------------------|--------------|
| Wing Spars | 17.9 | 8.5 | 1.6 | | 0.5 | 28.5 |
| Torsion Bracing | | 3.8 | 1.9 | | | 5.7 |
| Ribs | | | 8.0 | | | 8.0 |
| T.E. and L.E. | | | 4.2 | | | 4.2 |
| Centre Box | 2.8 | 1.8 | | | 1.4 | 6.0 |
| Ailerons | | 0.5 | 0.9 | 0.5 | 0.9 | 2.8 |
| Covering | | | | 4.6 | | 4.6 |
| WING | 20.7 | 14.6 | 16.6 | 5.1 | 2.8 | 59.8 |
| Crew Support | | | | 0.3 | 19.1 | 19.4 |
| Wheels | | | | | 3.1 | 3.1 |
| Front Fairing | | | | 0.7 | 2.7 | 3.4 |
| Rear Fuselage | 1.2 | 0.5 | 4.8 | 0.2 | 1.4 | 8.1 |
| FUSELAGE | 1.2 | 0.5 | 4.8 | 1.2 | 26.3 | 34.0 |
| Propeller | | | 1.9 | | 0.5 | 2.4 |
| Tailplane & Fin | | | 3.4 | 0.2 | 0.2 | 3.8 |
| TOTAL % | 21.9 | 15.1 | 26.7 | 6.5 | 29.8 | 100.0 |

Fig 5: Aircraft Percentage Weight Breakdown Two Seat Aircraft Toucan 1

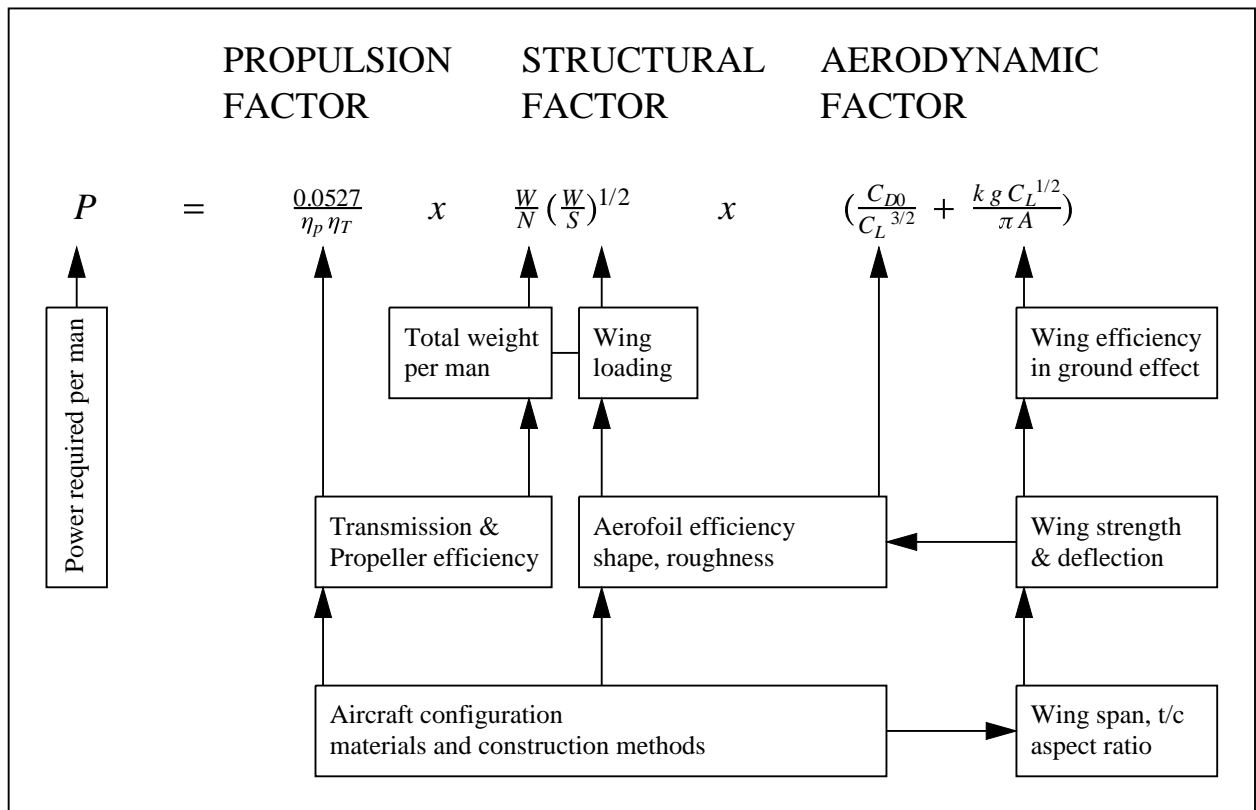

Fig 6: Structural Design Influence on Power Requirement

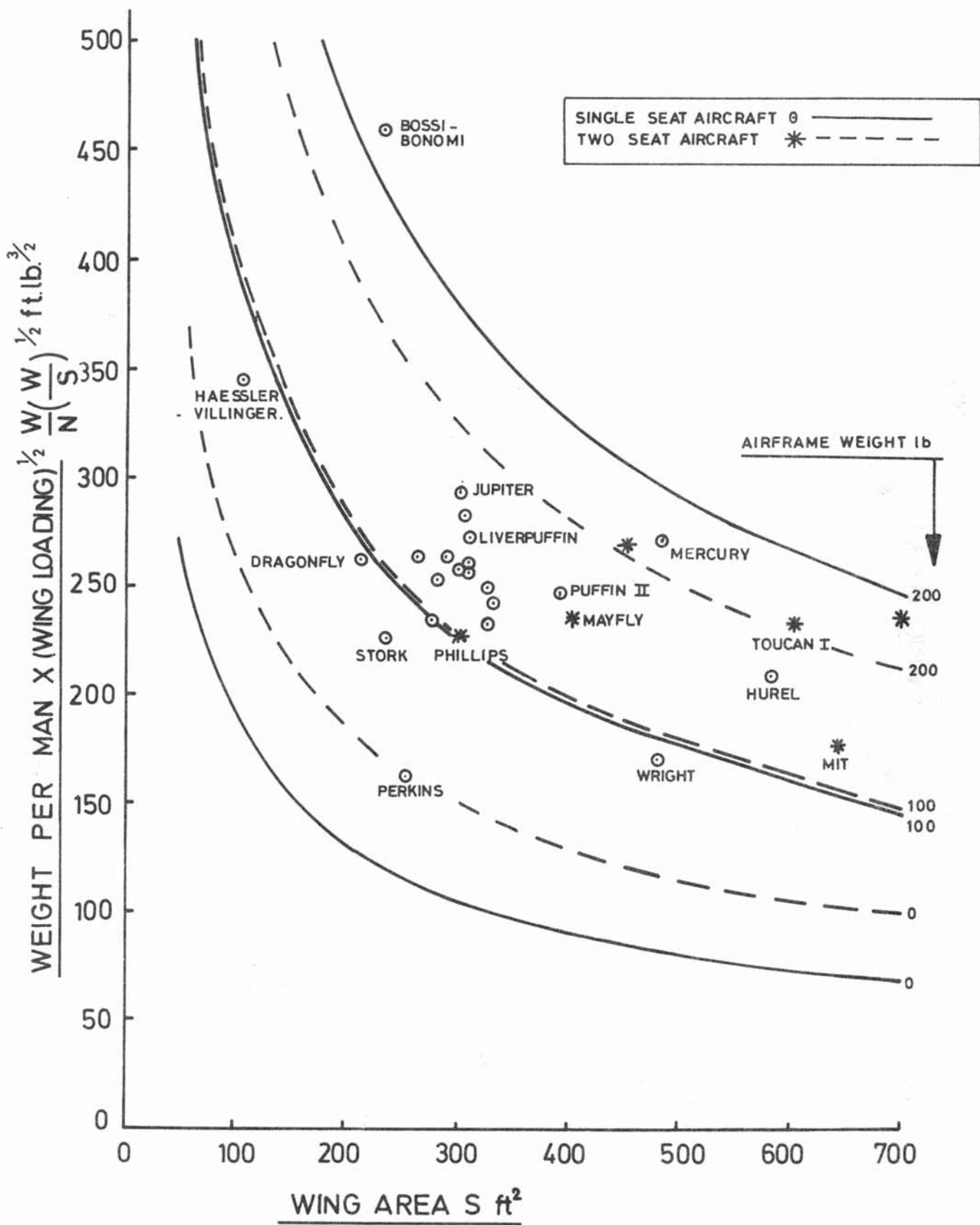

Fig 7: Man-Powered Aircraft Relative Performance Structural Factor

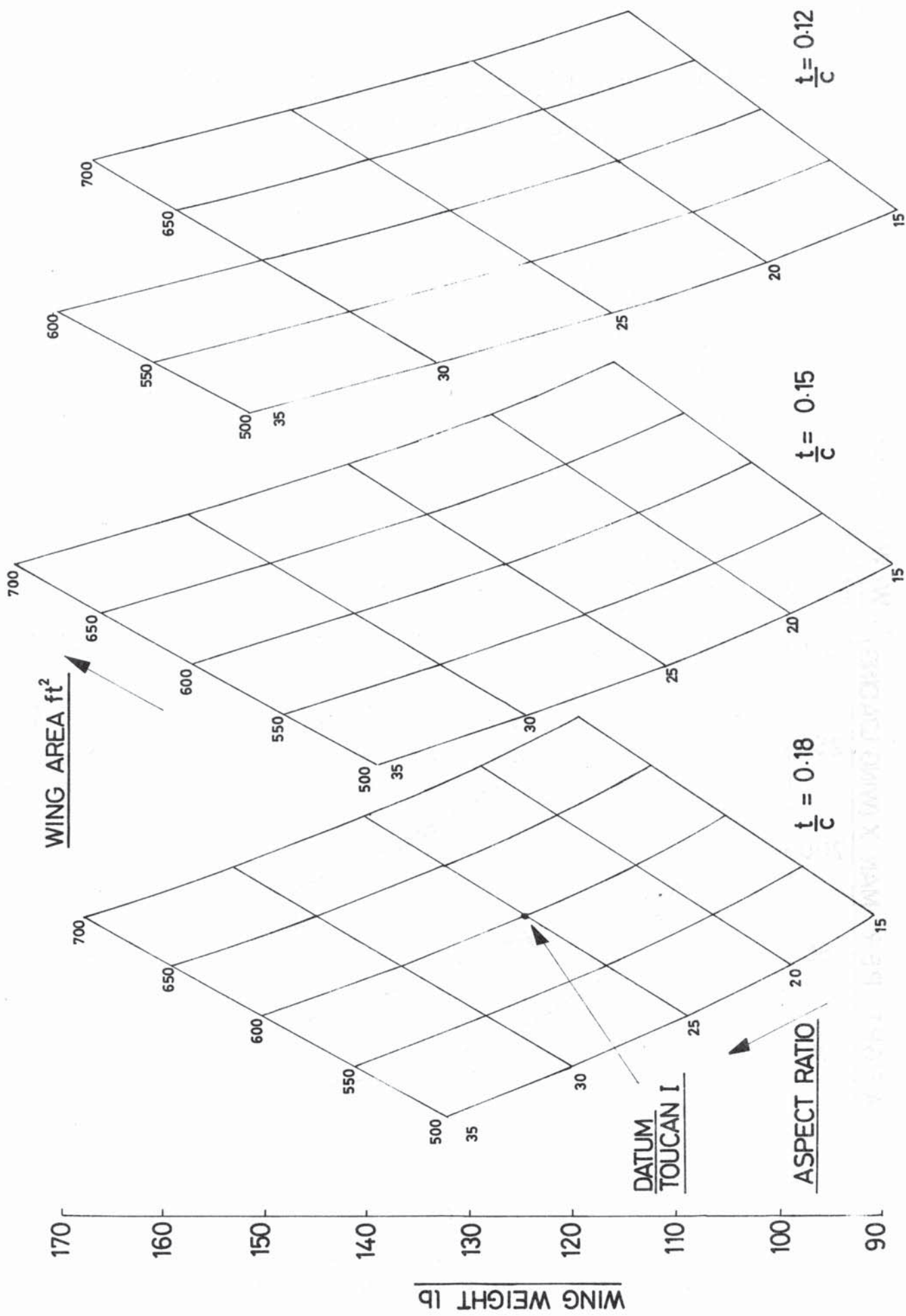

Fig 8: Two Seat Aircraft Wing Weight

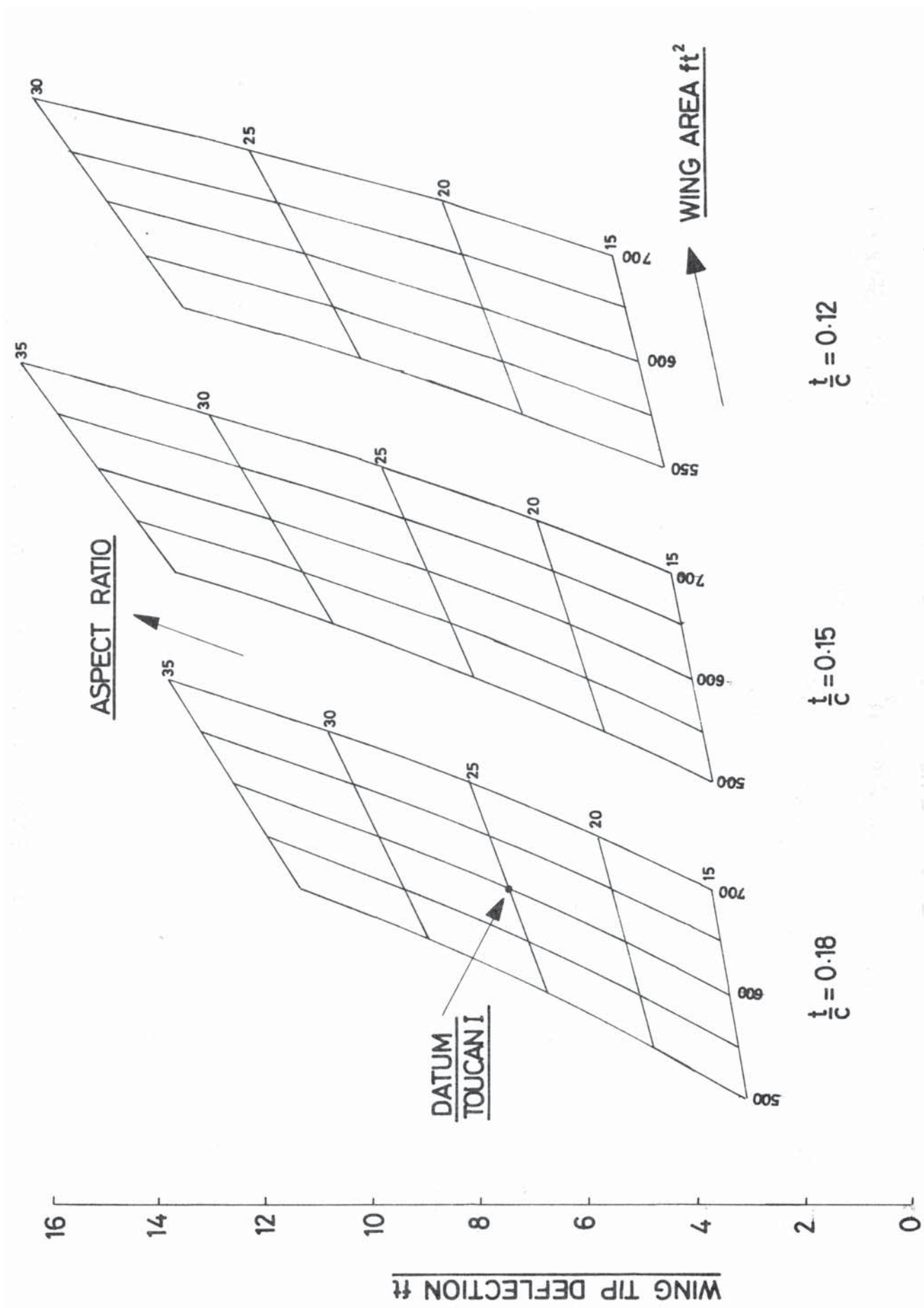

Fig 9: Two Seat Aircraft Wing Tip Deflection

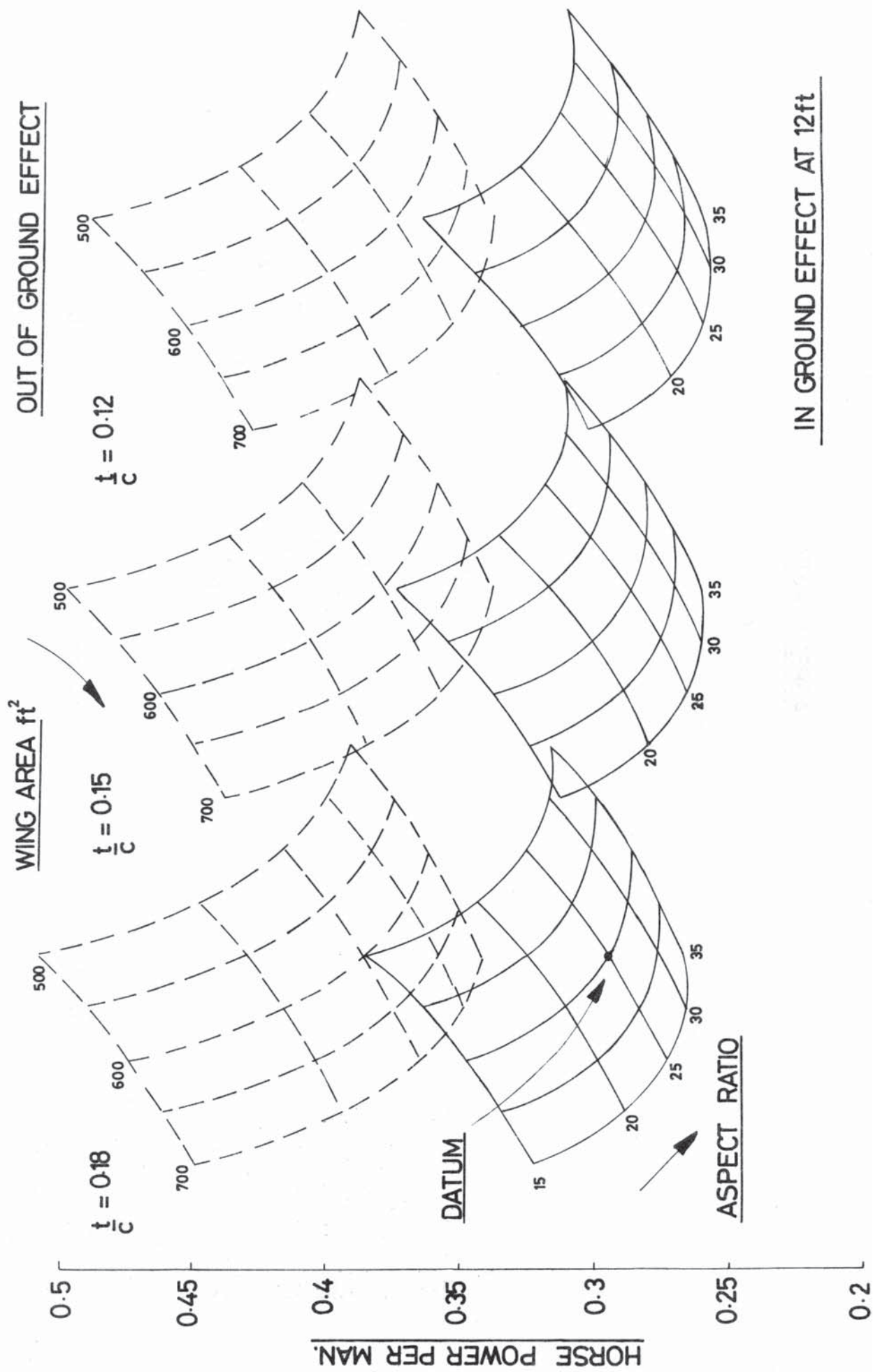

Fig 8: Two Seat Aircraft Power Requirement $C_L = 1.0$

| MATERIAL | PROPERTIES | | | SPECIFIC PROPERTIES | | | |
|--------------------|------------------------------------|--|---|--|--|---|--|
| | Density d lb/in ³ | Modulus E x 10 ⁻⁶ lbf/in ² | UTS ft x 10 ⁻³ lbf/in ² | Tensile Strength ft/d x 10 ⁻³ in | Bending Strength $\frac{f_l}{d^2} \times 10^{-6}$ in ⁴ /lbf ² | Axial Stiffness $\frac{E}{d}$ in | Buckling Solid Sect. $\frac{E}{d^2} \times 10^{-6}$ in ⁴ /lbf ² |
| Exp. Polystyrene | .0006 | .00045 | 0.03 | 50 | 83 | 0.75 | 1,250 |
| Balsa soft | .0032 | .30 | 0.92 | 288 | 90 | 94 | 29,380 |
| Balsa hard | .0069 | .87 | 3.46 | 501 | 73 | 126 | 18,260 |
| Spruce grade A | .0144 | 1.50 | 10.0 | 694 | 48 | 104 | 7,222 |
| Carbon Fibre | .0646 | 32.0 | 330.0 | 5108 | 79 | 495 | 7,663 |
| Magnesium Aly | .0650 | 6.50 | 29.0 | 446 | 6.9 | 100 | 1,538 |
| Glass Fibre | .067 | 2.8 | 34.0 | 507 | 7.6 | 42 | 627 |
| Aluminium Aly | .101 | 10.0 | 63.0 | 624 | 6.2 | 99 | 980 |
| Titanium Aly | .163 | 17.5 | 156.8 | 980 | 6.0 | 109 | 681 |
| High Tensile Steel | .285 | 29.0 | 125.0 | 439 | 0.17 | 102 | 363 |

Fig 11: Material Specific Properties

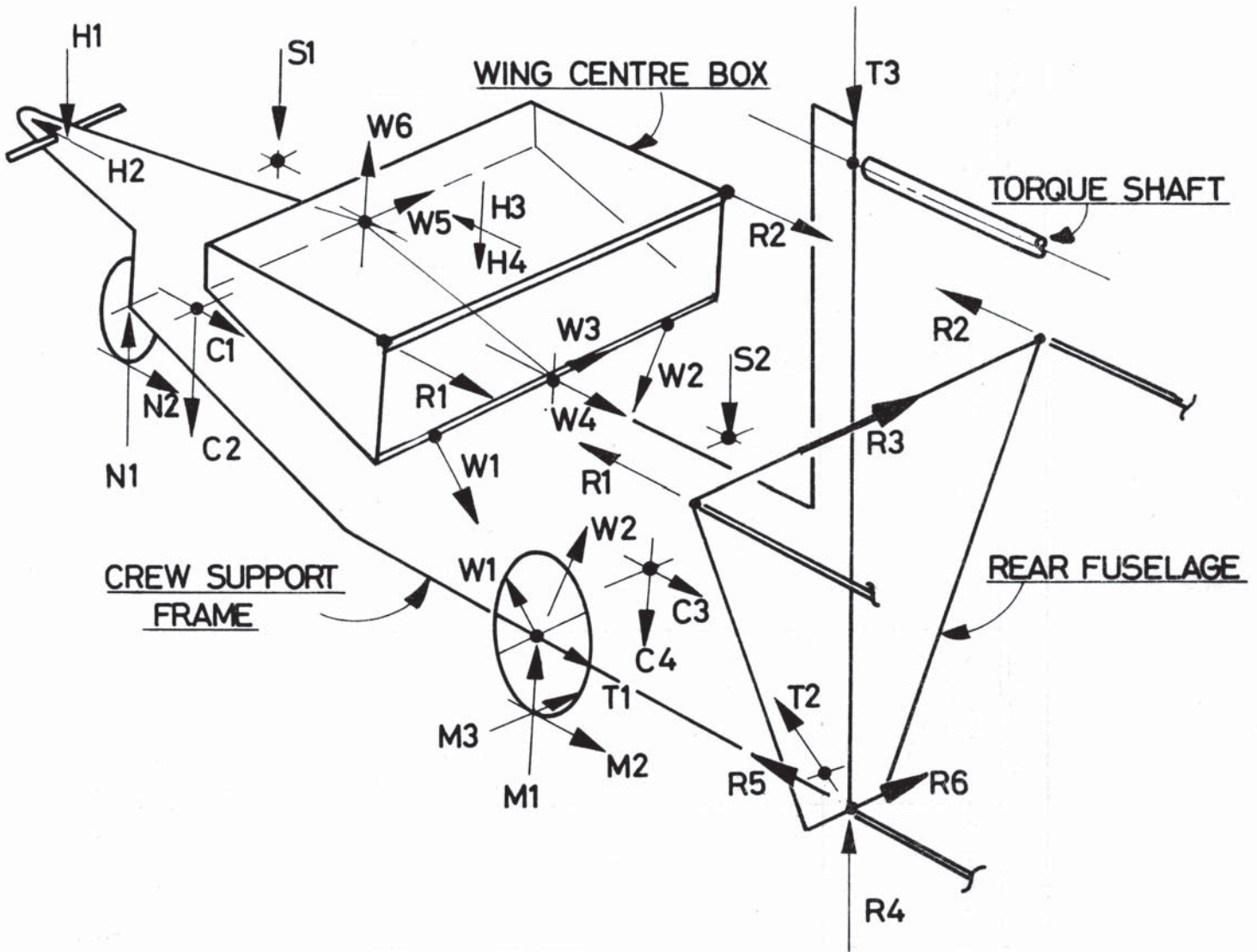
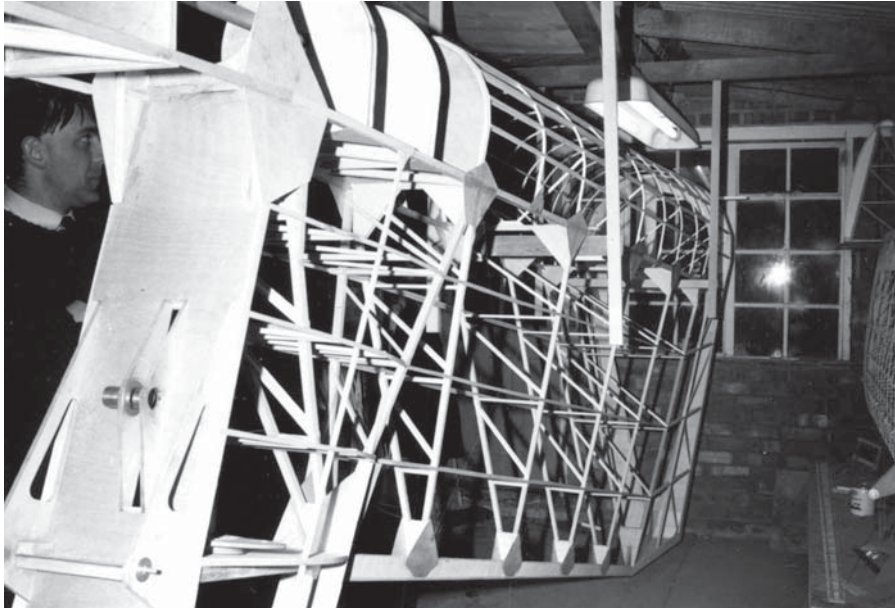
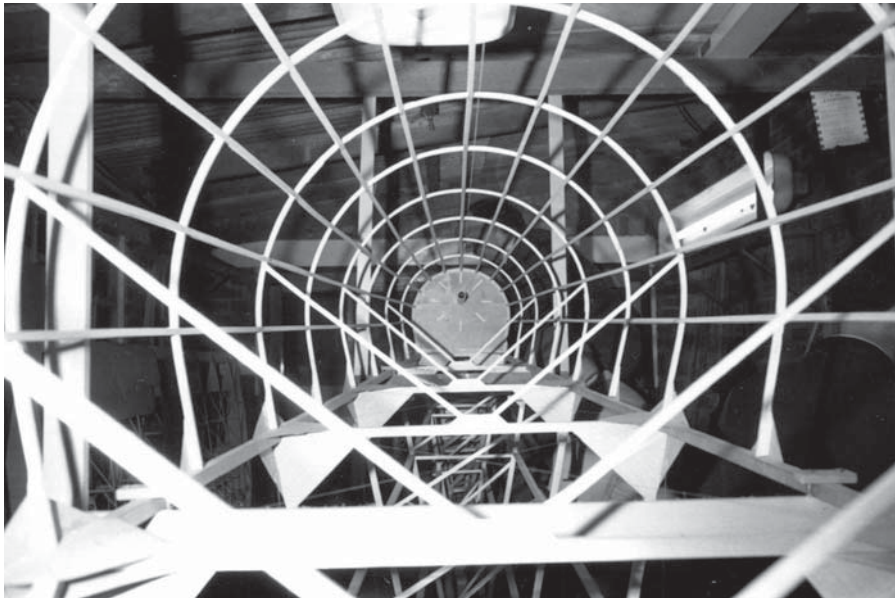

Fig 12: Major Forces Arising at the Wing Fuselage Intersection of Toucan 1



Rear fuselage, triangular balsa frames, spruce longerons



Top fairing, laminated balsa hoops, I-section stringers



Propeller, balsa laminated outline, ribs and sheeting



Crew support frame for two men, 30 SWG aly sheet

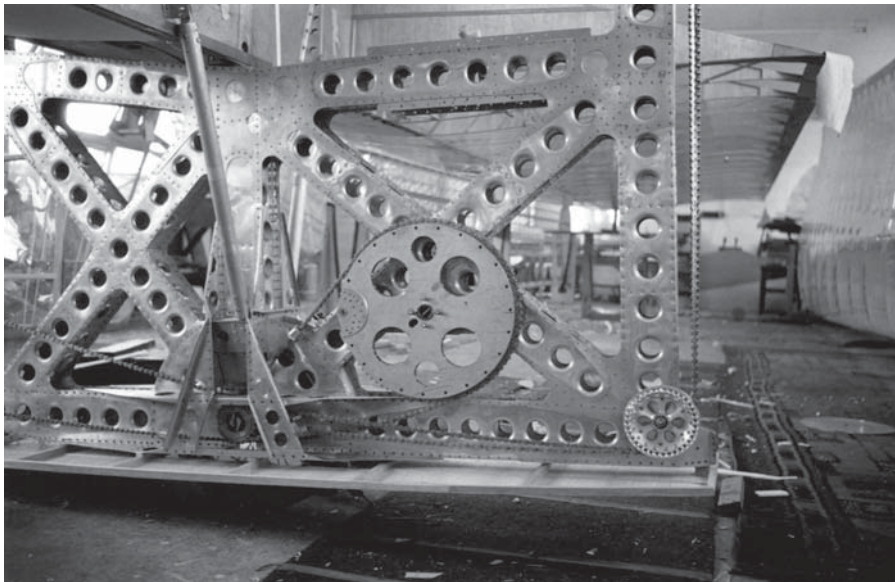

Wing attachment, sprocket wheel, idler, and al aly chains

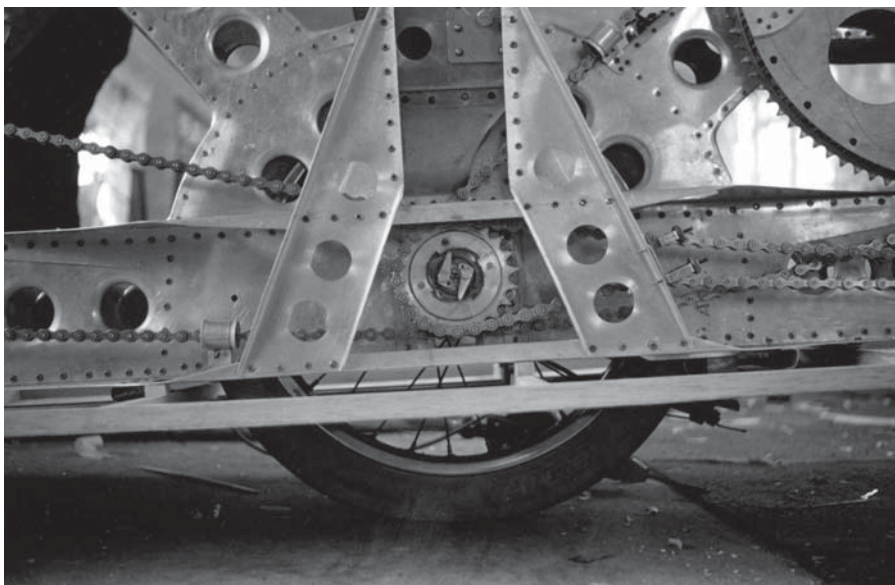

Chain drive to and from road wheel, free wheel clutch



Wing assembly, spruce and ply spar, balsa nose spar and ribs



Braced box inverted, aileron slot sub-assembly, TE and ribs

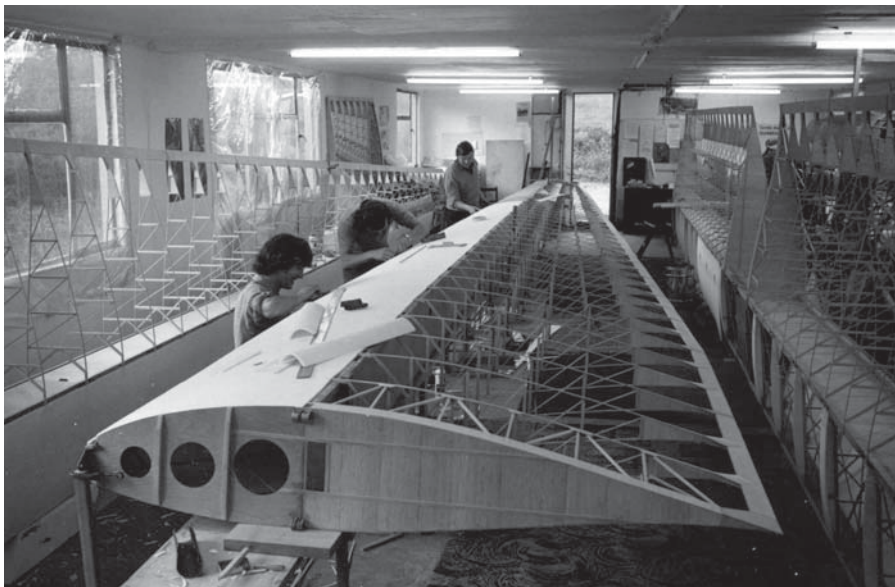

Polystyrene nose formers with sheeting and pre cut LE

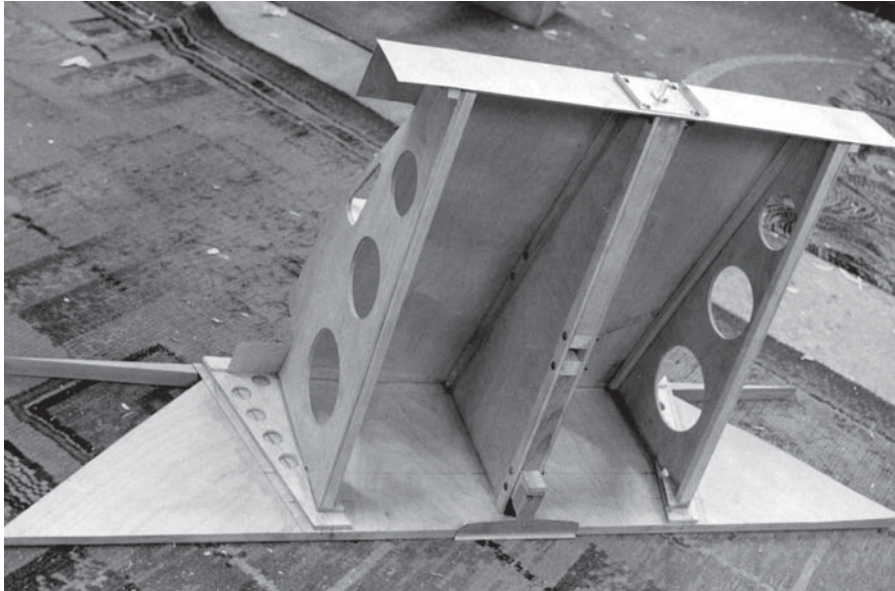

Wing centre box sub assembly, ply ribs for main attachments

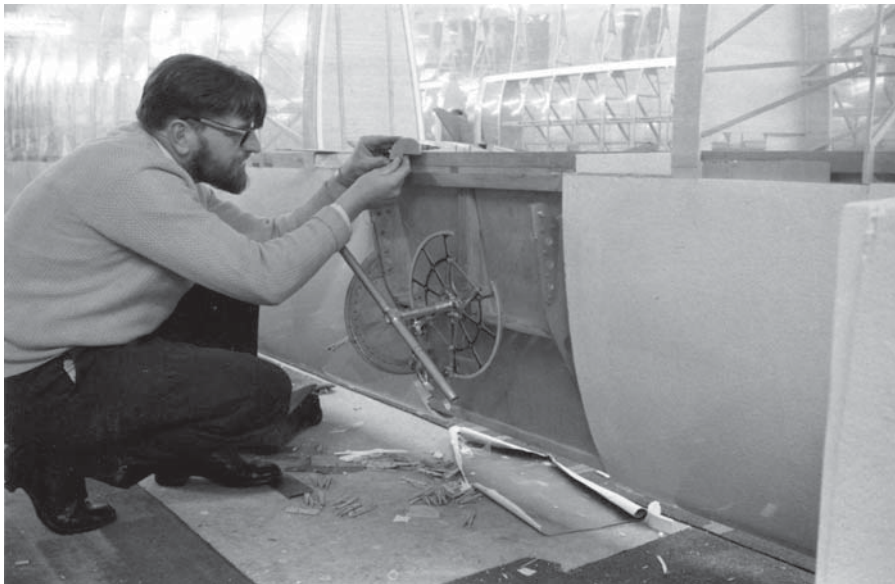

Centre box installed, pilots controls, rear fuselage attachments

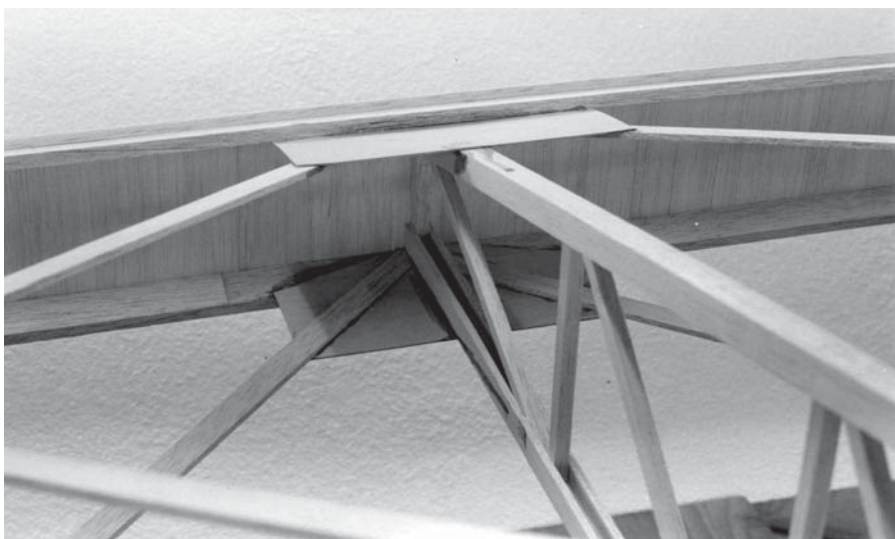

Balsa nose spar, ply gussets attach main ribs and bracing

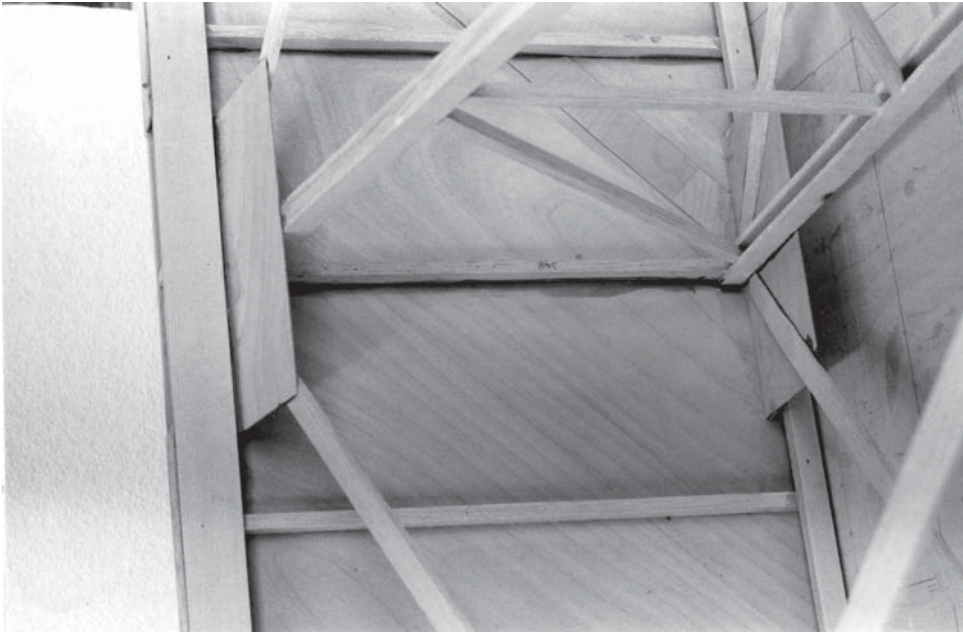

Twin flange main spar with diagonal web and capping, balsa stiffeners, main ribs and spruce diagonal bracing.

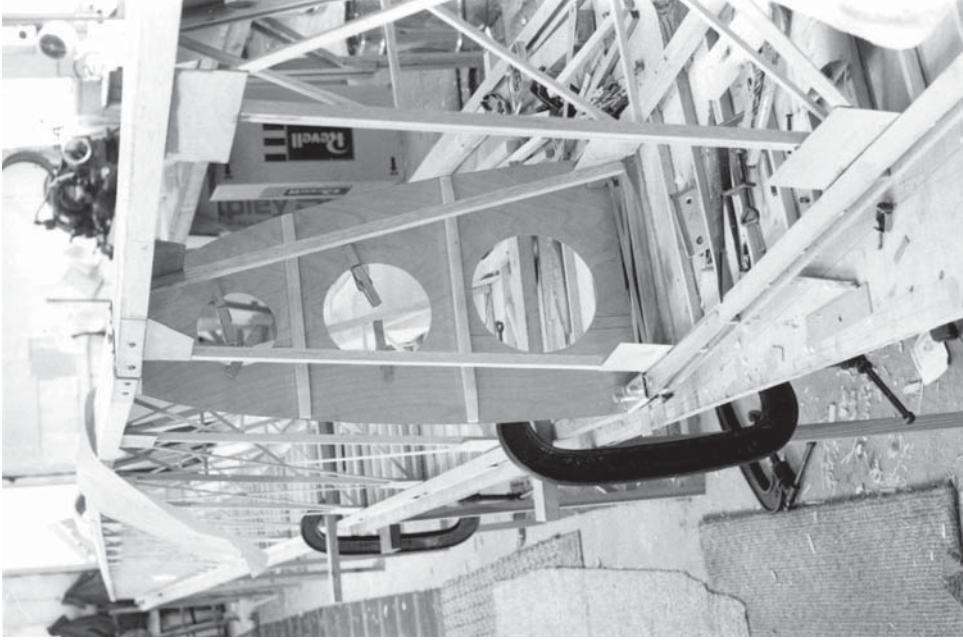

Inner wing main box stub at transport joint, alignment for dihedral. Tapering at aly lug reinforcements, flange and shear links.



Martyn Pressnell working on the fin attachment frame and propeller shaft fairing, jiggged on the shaft itself for alignment.